

Q2**HOLBA**

Corporate Office : Aakash Tower, 8, Pusa Road, New Delhi-110005 | Ph.: 011-47623456

Answers & Solutions

Time : 3 hrs. 20 Min.

M.M. : 720

*for***NEET (UG)-2022****Important Instructions :**

1. The test is of **3.20 hours** duration and the Test Booklet contains **200** multiple choice questions (Four options with a single correct answer). There are two sections in each subject, i.e. Section-A & Section-B. You have to attempt all 35 questions from Section-A & only 10 questions from Section-B out of 15. (**Candidates are advised to read all 15 questions in each subject of Section-B** before they start attempting the question paper. In the event of a candidate attempting more than ten questions, **the first ten questions answered by the candidate shall be evaluated.**)
2. Each question carries **4 marks**. For each correct response, the candidate will get **4 marks**. For every wrong response **1 mark** shall be deducted from the total scores. The maximum marks are **720**.
3. Use **Blue / Black Ball point Pen only** for writing particulars on this page / marking responses on Answer Sheet.
4. Rough work is to be done in the space provided for this purpose in the Test Booklet only.
5. On completion of the test, the candidate must handover the Answer Sheet to the Invigilator before leaving the Room / Hall. The candidates are allowed to take away this Test Booklet with them.
6. The CODE for this Booklet is **Q2**.
7. The candidates should ensure that the Answer Sheet is not folded. Do not make any stray marks on the Answer Sheet. Do not write your Roll No. anywhere else except in the specified space in the Test Booklet/Answer Sheet. Use of white fluid for correction is **NOT** permissible on the Answer Sheet.
8. Each candidate must show on-demand his/her Admission Card to the Invigilator.
9. No candidate, without special permission of the Centre Superintendent or Invigilator, would leave his/her seat.
10. Use of Electronic/Manual Calculator is prohibited.
11. The candidates are governed by all Rules and Regulations of the examination with regard to their conduct in the Examination Hall. All cases of unfair means will be dealt with as per Rules and Regulations of this examination.
12. No part of the Test Booklet and Answer Sheet shall be detached under any circumstances.
13. The candidates will write the Correct Test Booklet Code as given in the Test Booklet / Answer Sheet in the Attendance Sheet.

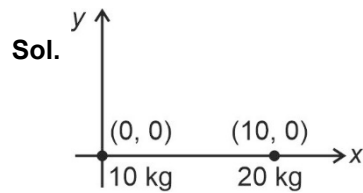

$$X_{\text{cm}} = \frac{m_1 x_1 + m_2 x_2}{m_1 + m_2}$$

$$= \frac{10 \times 0 + 20 \times 10}{10 + 20}$$

$$= \frac{200}{30}$$

$$= \frac{20}{3} \text{ m}$$

4. The angle between the electric lines of force and the equipotential surface is

- (1) 0° (2) 45°
 (3) 90° (4) 180°

Answer (3)

Sol. $dV = -\vec{E} \cdot d\vec{r}$

$$dV = -E dr \cos \theta$$

For equipotential surface,

$$dV = 0$$

$$\cos \theta = 0$$

$$\Rightarrow \theta = 90^\circ$$

5. In a Young's double slit experiment, a student observes 8 fringes in a certain segment of screen when a monochromatic light of 600 nm wavelength is used. If the wavelength of light is changed to 400 nm, then the number of fringes he would observe in the same region of the screen is

- (1) 6 (2) 8
 (3) 9 (4) 12

Answer (4)

Sol. $\beta = \frac{\lambda D}{d}$

Let length of segment of screen = l

$$\Rightarrow l = 8\beta_1 = \frac{8\lambda_1 D}{d} \quad \dots(1)$$

$$\text{and } l = n\beta_2 = \frac{n\lambda_2 D}{d} \quad \dots(2)$$

from (1) and (2)

$$8\lambda_1 = n\lambda_2$$

$$8(600 \text{ nm}) = n(400 \text{ nm})$$

$$n = 12$$

6. A body of mass 60 g experiences a gravitational force of 3.0 N, when placed at a particular point. The magnitude of the gravitational field intensity at that point is
- (1) 0.05 N/kg (2) 50 N/kg
 (3) 20 N/kg (4) 180 N/kg

Answer (2)

Sol. $F = mE_G$

$$3 = \frac{60}{1000} E_G$$

$$E_G = 50 \text{ N/kg}$$

7. A square loop of side 1 m and resistance 1Ω is placed in a magnetic field of 0.5 T. If the plane of loop is perpendicular to the direction of magnetic field, the magnetic flux through the loop is
- (1) 2 weber (2) 0.5 weber
 (3) 1 weber (4) Zero weber

Answer (2)

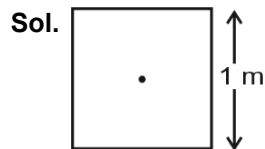

$$\text{Magnetic flux } (\phi_B) = \vec{B} \cdot \vec{A}$$

\vec{B} and \vec{A} are in same direction, therefore

$$\begin{aligned} \phi_B &= B.A = 0.5 \times 1^2 \\ &= 0.5 \text{ Wb} \end{aligned}$$

8. Plane angle and solid angle have
- (1) Units but no dimensions (2) Dimensions but no units
 (3) No units and no dimensions (4) Both units and dimensions

Answer (1)

Sol. Plane angle = $\frac{\text{Arc}}{\text{Radius}} = \frac{[L]}{[L]} \rightarrow \text{Unit} = \text{Radian}$

$$= [M^0 L^0 T^0]$$

Solid angle = $\frac{\text{Area}}{(\text{Radius})^2} \rightarrow \text{Unit} = \text{Steradian}$

$$= \frac{L^2}{L^2} = [M^0 L^0 T^0]$$

\therefore Both have units but no dimensions

9. The energy that will be ideally radiated by a 100 kW transmitter in 1 hour is
- (1) $36 \times 10^7 \text{ J}$ (2) $36 \times 10^4 \text{ J}$
 (3) $36 \times 10^5 \text{ J}$ (4) $1 \times 10^5 \text{ J}$

Answer (1)

Sol. Energy = Power \times time

$$\begin{aligned} E &= 100 \times 10^3 \times 3600 \\ &= 36 \times 10^7 \text{ J} \end{aligned}$$

10. The graph which shows the variation of the de Broglie wavelength (λ) of a particle and its associated momentum (p) is

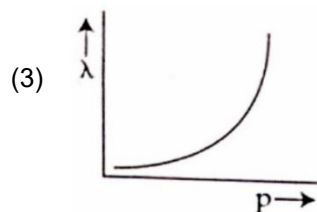
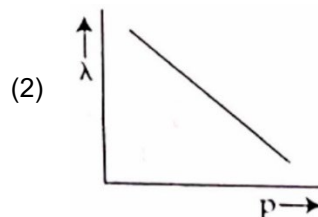
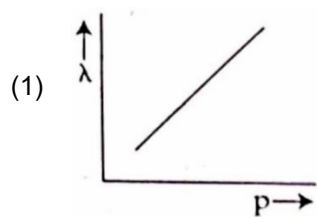

Answer (4)

Sol. de-Broglie wavelength associated with a particle is given by

$$\lambda = \frac{h}{p}$$

$$\lambda \propto \frac{1}{p}$$

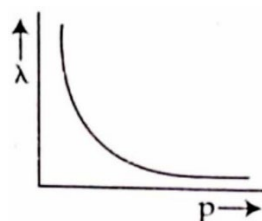

11. When light propagates through a material medium of relative permittivity ϵ_r and relative permeability μ_r , the velocity of light, v is given by (c -velocity of light in vacuum)

(1) $v = c$

(2) $v = \sqrt{\frac{\mu_r}{\epsilon_r}}$

(3) $v = \sqrt{\frac{\epsilon_r}{\mu_r}}$

(4) $v = \frac{c}{\sqrt{\epsilon_r \mu_r}}$

Answer (4)

Sol. $v = \frac{1}{\sqrt{\epsilon_m \mu_m}}$

$$v = \frac{1}{\sqrt{\epsilon_0 \epsilon_r \mu_0 \mu_r}}$$

Since $c = \frac{1}{\sqrt{\epsilon_0 \mu_0}}$

$$\Rightarrow v = \frac{c}{\sqrt{\epsilon_r \mu_r}}$$

15. The ratio of the distances travelled by a freely falling body in the 1st, 2nd, 3rd and 4th second

(1) 1 : 2 : 3 : 4

(2) 1 : 4 : 9 : 16

(3) 1 : 3 : 5 : 7

(4) 1 : 1 : 1 : 1

Answer (3)

Sol. $S_{n^{\text{th}}} = u + \frac{1}{2}a(2n - 1)$

$$S_{1^{\text{st}}} = \frac{1}{2}g(2 \times 1 - 1) = \frac{g}{2}$$

$$S_{2^{\text{nd}}} = \frac{1}{2}g(2 \times 2 - 1) = 3\left(\frac{1}{2}g\right)$$

$$S_{3^{\text{rd}}} = \frac{1}{2}g(2 \times 3 - 1) = 5 \times \left(\frac{1}{2}g\right)$$

$$S_{4^{\text{th}}} = \frac{1}{2}g(2 \times 4 - 1) = 7 \times \left(\frac{1}{2}g\right)$$

$$S_{1^{\text{st}}} : S_{2^{\text{nd}}} : S_{3^{\text{rd}}} : S_{4^{\text{th}}}$$

$$= 1 : 3 : 5 : 7$$

16. A biconvex lens has radii of curvature, 20 cm each. If the refractive index of the material of the lens is 1.5, the power of the lens is

(1) +2 D

(2) +20 D

(3) +5 D

(4) Infinity

Answer (3)

Sol. Power of lens is given by

$$P = \frac{1}{f(m)}$$

$$\frac{1}{f} = (\mu - 1) \left(\frac{1}{R_1} - \frac{1}{R_2} \right)$$

$$\frac{1}{f} = \left\{ \frac{3}{2} - 1 \right\} \left(\frac{1}{20} + \frac{1}{20} \right)$$

$$f = 20 \text{ cm}$$

$$P = \frac{1}{20 \times 10^{-2}}$$

$$= 5 \text{ D}$$

17. A copper wire of length 10 m and radius $\left(\frac{10^{-2}}{\sqrt{\pi}}\right)$ m has electrical resistance of 10 Ω . The current density in the wire for an electric field strength of 10 (V/m) is

(1) 10^4 A/m²

(2) 10^6 A/m²

(3) 10^{-5} A/m²

(4) 10^5 A/m²

Answer (4)

Sol. Resistance, $R = \rho \frac{L}{A} = \frac{L}{\sigma A}$

$$\Rightarrow \sigma = \frac{L}{RA}$$

Also current density $j = \sigma E = \frac{LE}{RA}$

$$j = \frac{10 \times 10}{10 \times \pi \left(\frac{10^{-2}}{\sqrt{\pi}} \right)^2} = \frac{100}{10 \times \pi \times \left(\frac{10^{-4}}{\pi} \right)}$$

$$= 10^5 \text{ A/m}^2$$

18. Match List-I with List-II

	List-I (Electromagnetic waves)		List-II (Wavelength)
(a)	AM radio waves	(i)	10^{-10} m
(b)	Microwaves	(ii)	10^2 m
(c)	Infrared radiations	(iii)	10^{-2} m
(d)	X-rays	(iv)	10^{-4} m

Choose the correct answer from the options given below

- (1) (a) - (iv), (b) - (iii), (c) - (ii), (d) - (i) (2) (a) - (iii), (b) - (ii), (c) - (i), (d) - (iv)
 (3) (a) - (iii), (b) - (iv), (c) - (ii), (d) - (i) (4) (a) - (ii), (b) - (iii), (c) - (iv), (d) - (i)

Answer (4)

Sol.

Waves	Wavelength
AM radio waves	10^2 m
Microwaves	10^{-2} m
Infrared radiations	10^{-4} m
X-rays	10^{-10} m

- (a) - (ii)
 (b) - (iii)
 (c) - (iv)
 (d) - (i)

19. The peak voltage of the ac source is equal to

- (1) The value of voltage supplied to the circuit (2) The rms value of the ac source
 (3) $\sqrt{2}$ times the rms value of the ac source (4) $1/\sqrt{2}$ times the rms value of the ac source

Answer (3)

Sol. We know,

$$\text{RMS value of A.C. } E_{\text{rms}} = \frac{E_0}{\sqrt{2}}$$

$$E_0 = \sqrt{2} E_{\text{rms}}$$

20. An electric lift with a maximum load of 2000 kg (lift + passengers) is moving up with a constant speed of 1.5 ms^{-1} . The frictional force opposing the motion is 3000 N. The minimum power delivered by the motor to the lift in watts is : ($g = 10 \text{ m s}^{-2}$)
- (1) 23000 (2) 20000
(3) 34500 (4) 23500

Answer (3)

Sol. $F_{\text{up}} = 2000g + 3000$
 $= 23000 \text{ N}$

Minimum power $P_{\text{min}} = \vec{F} \cdot \vec{v}$

$$P_{\text{min}} = Fv = 23000 \times \frac{3}{2}$$

$$= 34500 \text{ W}$$

21. If the initial tension on a stretched string is doubled, then the ratio of the initial and final speeds of a transverse wave along the string is
- (1) 1 : 1 (2) $\sqrt{2} : 1$
(3) $1 : \sqrt{2}$ (4) 1 : 2

Answer (3)

Sol. We know, velocity of transverse wave

$$v = \sqrt{\frac{T}{\mu}}$$

$$\therefore v_i = \sqrt{\frac{T}{\mu}} \text{ and } v_f = \sqrt{\frac{2T}{\mu}}$$

$$\therefore \frac{v_i}{v_f} = \frac{1}{\sqrt{2}}$$

22. If a soap bubble expands, the pressure inside the bubble
- (1) Decreases (2) Increases
(3) Remains the same (4) Is equal to the atmospheric pressure

Answer (1)

Sol. Excess pressure inside the bubble = $\Delta P = \frac{4T}{R}$

$$P_{\text{in}} = P_{\text{out}} + \frac{4T}{R}$$

as 'R' increases 'P' decreases

23. In the given nuclear reaction, the element X is

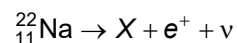

- (1) ${}_{11}^{23}\text{Na}$ (2) ${}_{10}^{23}\text{Ne}$
(3) ${}_{10}^{22}\text{Ne}$ (4) ${}_{12}^{22}\text{Mg}$

Answer (3)

Sol. The nuclear reaction is given as

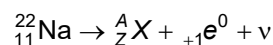

From conservation of atomic number

$$11 = Z + 1 \Rightarrow Z = 10 \Rightarrow \text{Ne}$$

From conservation of mass number

$$22 = A + 0 \Rightarrow A = 22$$

$$\therefore {}_Z^A X = {}_{10}^{22}\text{Ne}$$

24. The dimensions $[MLT^{-2}A^{-2}]$ belong to the
- (1) Magnetic flux (2) Self inductance
 (3) Magnetic permeability (4) Electric permittivity

Answer (3)

Sol. Dimensional formula of magnetic permeability is $[MLT^{-2}A^{-2}]$

25. As the temperature increases, the electrical resistance
- (1) Increases for both conductors and semiconductors
 (2) Decreases for both conductors and semiconductors
 (3) Increases for conductors but decreases for semiconductors
 (4) Decreases for conductors but increases for semiconductors

Answer (3)

Sol. As the temperature increases the resistivity of the conductor increases hence the electrical resistance increases. However for semiconductor the resistivity decreases with the temperature. Hence electrical resistance of semiconductor decreases.

26. Given below are two statements

Statement I : Biot-Savart's law gives us the expression for the magnetic field strength of an infinitesimal current element (Idl) of a current carrying conductor only.

Statement II : Biot-Savart's law is analogous to Coulomb's inverse square law of charge q , with the former being related to the field produced by a scalar source, Idl while the latter being produced by a vector source, q .

In light of above statements choose the most appropriate answer from the options given below

- (1) Both Statement I and Statement II are correct
 (2) Both Statement I and Statement II are incorrect
 (3) Statement I is correct and Statement II is incorrect
 (4) Statement I is incorrect and Statement II is correct

Answer (3)

Sol. According to Biot-Savart's law $d\vec{B} = \frac{\mu_0}{4\pi} \frac{Id\vec{l} \times \vec{r}}{r^3}$ which is applicable for infinitesimal element. It is

analogous to Coulomb's law, where $Id\vec{l}$ is vector source and electric field is produced by scalar source q .

Here statement I is correct and statement II is incorrect.

27. Let T_1 and T_2 be the energy of an electron in the first and second excited states of hydrogen atoms, respectively. According to the Bohr's model of an atom, the ratio $T_1 : T_2$ is

- (1) 1 : 4 (2) 4 : 1
 (3) 4 : 9 (4) 9 : 4

Answer (4)

Sol. $E_n = \frac{E_0}{n^2}$, For first excited state $\Rightarrow n = 2$

For second excited state $\Rightarrow n = 3$

$$\Rightarrow \frac{T_1}{T_2} = \frac{\frac{E_0}{4}}{\frac{E_0}{9}} = \frac{9}{4}$$

28. A light ray falls on a glass surface of refractive index $\sqrt{3}$, at an angle 60° . The angle between the refracted and reflected rays would be
- (1) 30° (2) 60°
 (3) 90° (4) 120°

Answer (3)

Sol. Given $i = 60^\circ$ and $\mu = \sqrt{3}$

\Rightarrow Here, angle of incidence $\Rightarrow i = \tan^{-1}(\mu)$

Hence, reflected and refracted rays would be perpendicular to each other.

29. The angular speed of a fly wheel moving with uniform angular acceleration changes from 1200 rpm to 3120 rpm in 16 seconds. The angular acceleration in rad/s^2 is
- (1) 2π (2) 4π
 (3) 12π (4) 104π

Answer (2)

Sol. Angular acceleration $\alpha = \frac{\omega_f - \omega_i}{t}$

$$\omega_f = 3120 \times \frac{2\pi}{60} \text{ rad/s}$$

$$\omega_i = 1200 \times \frac{2\pi}{60} \text{ rad/s}$$

$$\Rightarrow \alpha = \frac{(3120 - 1200)}{16} \times \frac{2\pi}{60} = 4\pi$$

30. A long solenoid of radius 1 mm has 100 turns per mm. If 1 A current flows in the solenoid, the magnetic field strength at the centre of the solenoid is
- (1) $6.28 \times 10^{-2} \text{ T}$ (2) $12.56 \times 10^{-2} \text{ T}$
 (3) $12.56 \times 10^{-4} \text{ T}$ (4) $6.28 \times 10^{-4} \text{ T}$

Answer (2)

Sol. We know, magnetic field at centre of solenoid

$$B = \mu_0 \frac{N}{\ell} I = \mu_0 n I \quad \left[n = \frac{N}{\ell} \right]$$

$$= 4\pi \times 10^{-7} \times 100 \times 10^3 \times 1 \quad \left[n = \frac{100}{10^{-3}} \right]$$

$$= 4\pi \times 10^{-2} \text{ T}$$

$$B = 12.56 \times 10^{-2} \text{ T}$$

31. In half wave rectification, if the input frequency is 60 Hz, then the output frequency would be
- (1) Zero (2) 30 Hz
 (3) 60 Hz (4) 120 Hz

Answer (3)

Sol. In half wave rectifier, the output frequency is same as that of input frequency.

32. The ratio of the radius of gyration of a thin uniform disc about an axis passing through its centre and normal to its plane to the radius of gyration of the disc about its diameter is
- (1) 2 : 1 (2) $\sqrt{2} : 1$
 (3) 4 : 1 (4) 1 : $\sqrt{2}$

Answer (2)

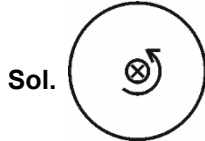

$$I_1 = \frac{MR^2}{2}$$

$$k_1 = \sqrt{\frac{I_1}{M}}$$

$$= \frac{R}{\sqrt{2}}$$

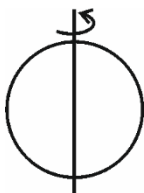

$$I_2 = \frac{MR^2}{4}$$

$$k_2 = \sqrt{\frac{I_2}{M}}$$

$$= \frac{R}{2}$$

$$\frac{k_1}{k_2} = \frac{\frac{R}{\sqrt{2}}}{\frac{R}{2}}$$

$$= \sqrt{2} : 1$$

33. An ideal gas undergoes four different processes from the same initial state as shown in the figure below. Those processes are adiabatic, isothermal, isobaric and isochoric. The curve which represents the adiabatic process among 1, 2, 3 and 4 is

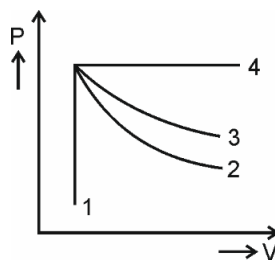

- (1) 1 (2) 2
 (3) 3 (4) 4

Answer (2)

Sol. $\left(\frac{dP}{dV}\right)_{\text{adiabatic}} = -\gamma P$
 $\left(\frac{dP}{dV}\right)_{\text{isothermal}} = -P$
 $\left(\frac{dP}{dV}\right)_{\text{adiabatic}} > \left(\frac{dP}{dV}\right)_{\text{isothermal}}$

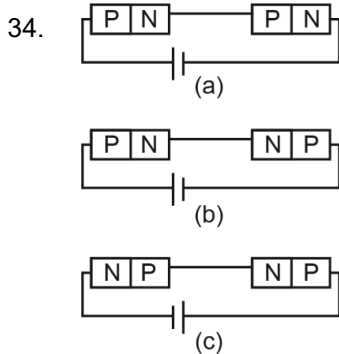
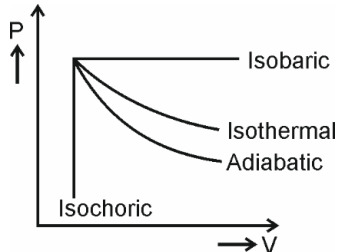

In the given circuits (a), (b) and (c), the potential drop across the two *p-n* junctions are equal in

- (1) Circuit (a) only
- (2) Circuit (b) only
- (3) Circuit (c) only
- (4) Both circuits (a) and (c)

Answer (4)

Sol. Potential drops across the *p-n* junctions will be same if either both junctions are forward biased or both junctions are reverse biased.

In figure (a) and (c), both junctions are forward biased therefore both have same potential.

In figure (b) first junction is forward biased and second junction is reverse biased, so both junctions have different potential difference.

35. A spherical ball is dropped in a long column of a highly viscous liquid. The curve in the graph shown, which represents the speed of the ball (v) as a function of time (t) is

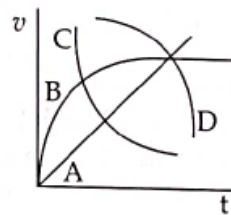

- (1) A
- (2) B
- (3) C
- (4) D

Answer (2)

Sol. Initial speed of ball is zero and it finally attains terminal speed

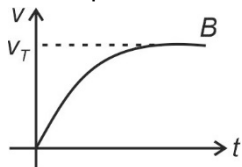

SECTION-B

36. A capacitor of capacitance $C = 900 \text{ pF}$ is charged fully by 100 V battery B as shown in figure (a). Then it is disconnected from the battery and connected to another uncharged capacitor of capacitance $C = 900 \text{ pF}$ as shown in figure (b). The electrostatic energy stored by the system (b) is

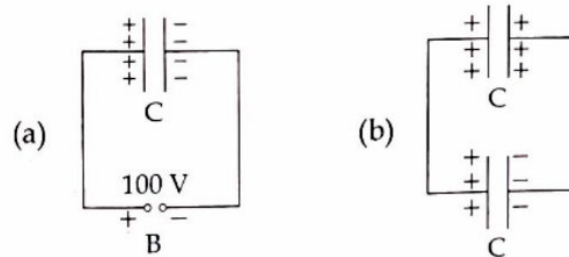

(1) $4.5 \times 10^{-6} \text{ J}$

(2) $3.25 \times 10^{-6} \text{ J}$

(3) $2.25 \times 10^{-6} \text{ J}$

(4) $1.5 \times 10^{-6} \text{ J}$

Answer (3)

Sol. $q_1 = CV$

$$= 900 \times 10^{-12} \times 100$$

$$= 9 \times 10^{-8} \text{ C}$$

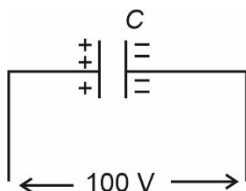

$$V = \frac{C_1 V_1 + C_2 V_2}{C_1 + C_2}$$

$$= \frac{9 \times 10^{-8} + 0}{1800 \times 10^{-12}} = \frac{100}{2} = 50 \text{ V}$$

$$U = \frac{1}{2}(C_1 + C_2)V^2$$

$$= \frac{1}{2} \times 1800 \times 10^{-12} \times 50 \times 50$$

$$= 225 \times 10^{-8}$$

$$U = 2.25 \times 10^{-6} \text{ J}$$

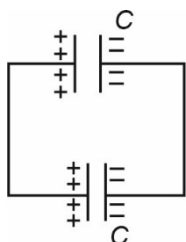

37. A nucleus of mass number 189 splits into two nuclei having mass number 125 and 64. The ratio of radius of two daughter nuclei respectively is
- (1) 1 : 1 (2) 4 : 5
 (3) 5 : 4 (4) 25 : 16

Answer (3)

Sol. Radius of nuclei with mass number A varies as

$$R = R_0 A^{1/3}$$

$$\frac{R_1}{R_2} = \left(\frac{125}{64} \right)^{1/3} = \frac{5}{4} = 5 : 4$$

38. Match List-I with List-II

	List-I		List-II
(a)	Gravitational constant (G)	(i)	$[L^2T^{-2}]$
(b)	Gravitational potential energy	(ii)	$[M^{-1}L^3T^{-2}]$
(c)	Gravitational potential	(iii)	$[LT^{-2}]$
(d)	Gravitational intensity	(iv)	$[ML^2T^{-2}]$

Choose the correct answer from the options given below

- (1) (a) - (ii), (b) - (i), (c) - (iv), (d) - (iii) (2) (a) - (ii), (b) - (iv), (c) - (i), (d) - (iii)
 (3) (a) - (ii), (b) - (iv), (c) - (iii), (d) - (i) (4) (a) - (iv), (b) - (ii), (c) - (i), (d) - (iii)

Answer (2)

Sol. (a) $[G] = \frac{Fr^2}{m_1m_2}$

$$[G] = \frac{Fr^2}{m_1m_2} = \frac{[MLT^{-2}] L^2}{[MM]} = [M^{-1}L^3T^{-2}]$$

(b) Gravitational potential energy = $[ML^2T^{-2}]$

(c) Gravitational potential = $\frac{PE}{m} = [L^2T^{-2}]$

(d) Gravitational field intensity = $\frac{F}{m} = [LT^{-2}]$

39. A wheatstone bridge is used to determine the value of unknown resistance X by adjusting the variable resistance Y as shown in the figure. For the most precise measurement of X , the resistances P and Q

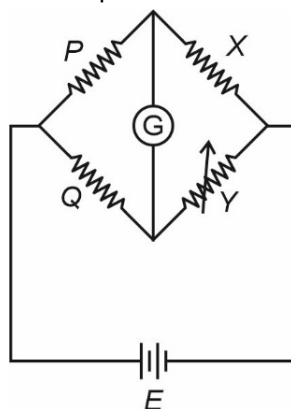

- (1) Should be approximately equal to $2X$ (2) Should be approximately equal and are small
 (3) Should be very large and unequal (4) Do not play any significant role

Answer (2)

Sol. We know, a wheatstone bridge is said to be most precise when it is most sensitive. This can be done by making ratio arms equal. Thus (2) is correct option.

40. Two pendulums of length 121 cm and 100 cm start vibrating in phase. At some instant, the two are at their mean position in the same phase. The minimum number of vibrations of the shorter pendulum after which the two are again in phase at the mean position is:

- (1) 11 (2) 9
(3) 10 (4) 8

Answer (1)

Sol. $T = 2\pi\sqrt{\frac{L}{g}}$

Let n_1 and n_2 be integer.

$$n_1 T_1 = n_2 T_2$$

$$2\pi n_1 \sqrt{\frac{1.21}{g}} = 2\pi n_2 \sqrt{\frac{1.00}{g}}$$

$$\Rightarrow \frac{n_2}{n_1} = \frac{11}{10}$$

\therefore After completion of 11th oscillation of shorter pendulum, it will be in phase with longer pendulum.

41. The area of a rectangular field (in m²) of length 55.3 m and breadth 25 m after rounding off the value for correct significant digits is

- (1) 138×10^1 (2) 1382
(3) 1382.5 (4) 14×10^2

Answer (4)

Sol. Area = Length \times Breadth

$$= 55.3 \times 25 \text{ m}^2$$

$$= 1382.5 \text{ m}^2$$

$$= 14 \times 10^2 \text{ m}^2 \text{ (Rounding off of two significant figures)}$$

42. A ball is projected with a velocity, 10 ms⁻¹, at an angle of 60° with the vertical direction. Its speed at the highest point of its trajectory will be

- (1) Zero (2) $5\sqrt{3} \text{ ms}^{-1}$
(3) 5 ms^{-1} (4) 10 ms^{-1}

Answer (2)

Sol. At highest point vertical component of velocity become zero.

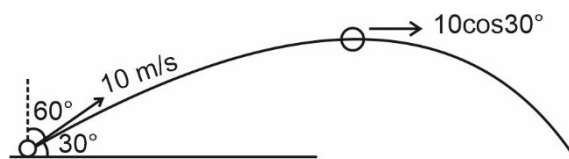

At highest point speed of object = $10 \cos 30^\circ$

$$= 5\sqrt{3} \text{ m/s}$$

43. Given below are two statements : One is labelled as **Assertion (A)** and the other is labelled as **Reason (R)**.

Assertion (A): The stretching of a spring is determined by the shear modulus of the material of the spring.

Reason (R): A coil spring of copper has more tensile strength than a steel spring of same dimensions.

In the light of the above statements, choose the **most appropriate** answer from the options given below

- (1) Both **(A)** and **(R)** are true and **(R)** is the correct explanation of **(A)**
- (2) Both **(A)** and **(R)** are true and **(R)** is not the correct explanation of **(A)**
- (3) **(A)** is true but **(R)** is false
- (4) **(A)** is false but **(R)** is true

Answer (3)

Sol. It is true that stretching of spring is determined by shear modulus of the spring as when coil spring is stretched neither its length nor its volume changes, there is only change in its shape.

Tensile strength of steel is more than that of copper.

Hence Assertion is true and reason is false.

44. Two point charges $-q$ and $+q$ are placed at a distance of L , as shown in the figure.

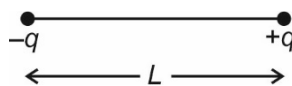

The magnitude of electric field intensity at a distance R ($R \gg L$) varies as:

- (1) $\frac{1}{R^2}$
- (2) $\frac{1}{R^3}$
- (3) $\frac{1}{R^4}$
- (4) $\frac{1}{R^6}$

Answer (2)

Sol. For $R \gg L$, arrangement is an electric dipole

$$E = \frac{2p}{4\pi\epsilon_0 R^3}; \text{ where } p = qL$$

$$E \propto \frac{1}{R^3}$$

45. From Ampere's circuital law for a long straight wire of circular cross-section carrying a steady current, the variation of magnetic field in the inside and outside region of the wire is

- (1) Uniform and remains constant for both the regions.
- (2) A linearly increasing function of distance upto the boundary of the wire and then linearly decreasing for the outside region.
- (3) A linearly increasing function of distance r upto the boundary of the wire and then decreasing one with $\frac{1}{r}$ dependence for the outside region.
- (4) A linearly decreasing function of distance upto the boundary of the wire and then a linearly increasing one for the outside region.

Answer (3)

Sol. For solid wire

Inside point

$$B = \frac{\mu_0 I r^2}{R^2 \times 2\pi r}$$

$$= \frac{\mu_0 I r}{R^2 \times 2\pi}$$

$$B \propto r$$

Outside point

$$B = \frac{\mu_0 I}{2\pi r}$$

$$B \propto \frac{1}{r}$$

46. Two transparent media A and B are separated by a plane boundary. The speed of light in those media are 1.5×10^8 m/s and 2.0×10^8 m/s, respectively. The critical angle for a ray of light for these two media is
- (1) $\sin^{-1}(0.500)$ (2) $\sin^{-1}(0.750)$
 (3) $\tan^{-1}(0.500)$ (4) $\tan^{-1}(0.750)$

Answer (2)

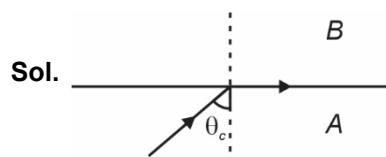

$$\mu_A = \frac{3 \times 10^8}{1.5 \times 10^8} = 2$$

$$\mu_B = \frac{3 \times 10^8}{2 \times 10^8} = 1.5$$

For TIR, ray of light should travel from denser to rarer medium

$$\mu_A \sin \theta_c = \mu_B \sin 90^\circ$$

$$2 \sin \theta_c = 1.5 \sin 90^\circ$$

$$\sin \theta_c = 0.75$$

$$\theta_c = \sin^{-1}(0.75)$$

47. The volume occupied by the molecules contained in 4.5 kg water at STP, if the intermolecular forces vanish away is
- (1) 5.6×10^6 m³ (2) 5.6×10^3 m³
 (3) 5.6×10^{-3} m³ (4) 5.6 m³

Answer (4)

Sol. From ideal gas equation

$$PV = nRT$$

$$\left[n = \frac{\text{mass of water}}{\text{mol. wt.}} = \frac{4.5 \times 10^3}{18} \right]$$

$$V = \frac{nRT}{P}$$

At. STP $\Rightarrow T = 273$ K

$$P = 10^5 \text{ N/m}^2$$

$$V = \frac{4.5 \times 10^3}{18} \times \frac{8.3 \times 273}{10^5} = 5.66 \text{ m}^3$$

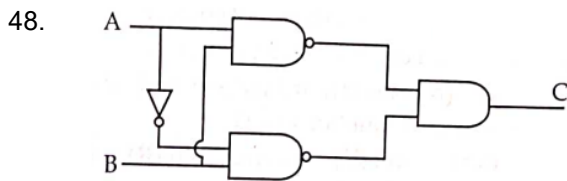

The truth table for the given logic circuit is

(1)

A	B	C
0	0	0
0	1	1
1	0	1
1	1	0

(2)

A	B	C
0	0	1
0	1	0
1	0	0
1	1	1

(3)

A	B	C
0	0	1
0	1	0
1	0	1
1	1	0

(4)

A	B	C
0	0	0
0	1	1
1	0	0
1	1	1

Answer (3)

Sol. $C = (\overline{A \cdot B}) \cdot (\overline{\overline{A} \cdot B})$

$$\Rightarrow C = \overline{A \cdot B + \overline{A} \cdot B}$$

$$\Rightarrow C = \overline{(A + \overline{A})B}$$

$$\Rightarrow C = \overline{B}$$

The truth table would be

A	B	C
0	0	1
0	1	0
1	0	1
1	1	0

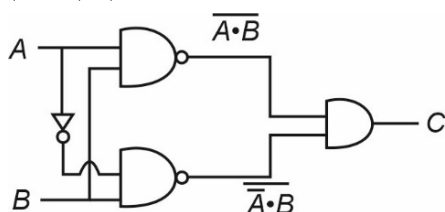

SECTION-A

51. Which amongst the following is **incorrect** statement?
- (1) The bond orders of O_2^+ , O_2 , O_2^- and O_2^{2-} are 2.5, 2, 1.5 and 1, respectively
 - (2) C_2 molecule has four electrons in its two degenerate π molecular orbitals
 - (3) H_2^+ ion has one electron
 - (4) O_2^+ ion is diamagnetic

Answer (4)

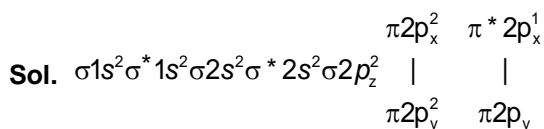

Due to one unpaired electron in $\pi^* 2p$ molecular orbital, O_2^+ is a paramagnetic ion.

52. Gadolinium has a low value of third ionisation enthalpy because of
- (1) small size
 - (2) high exchange enthalpy
 - (3) high electronegativity
 - (4) high basic character

Answer (2)

Sol. Electronic configuration of Gadolinium

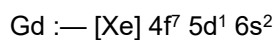

In case of 3rd ionisation enthalpy electron will be removed from 5d and resultant configuration will be [Xe] $4f^7$ that is stable electronic configuration as it will have high exchange energy, hence less energy will be required to remove 3rd electron.

53. Identify the **incorrect** statement from the following.
- (1) All the five 5d orbitals are different in size when compared to the respective 4d orbitals.
 - (2) All the five 4d orbitals have shapes similar to the respective 3d orbitals.
 - (3) In an atom, all the five 3d orbitals are equal in energy in free state.
 - (4) The shapes of d_{xy} , d_{yz} and d_{zx} orbitals are similar to each other; and $d_{x^2-y^2}$ and d_{z^2} are similar to each other.

Answer (4)

Sol. • In an atom, all the five 3d orbitals are equal in energy in free state *i.e.*, degenerate.

- The shape of $d_{x^2-y^2}$ is different than shape of d_{z^2}

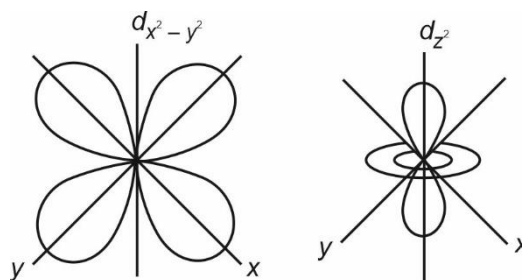

- The size of orbital depends on principal quantum number 'n' therefore all the five 3d orbitals are different in size when compared to the respective 4d orbitals.
- Shape of orbitals depends on azimuthal quantum number 'l' therefore shapes of 4d orbitals are similar to the respective 3d orbitals.

54. Which of the following p-V curve represents maximum work done?



Answer (2)

Sol. Work done under any thermodynamic process can be determined by area under the 'p-V' graph.

As it can be observed maximum area is covered in option '2'.

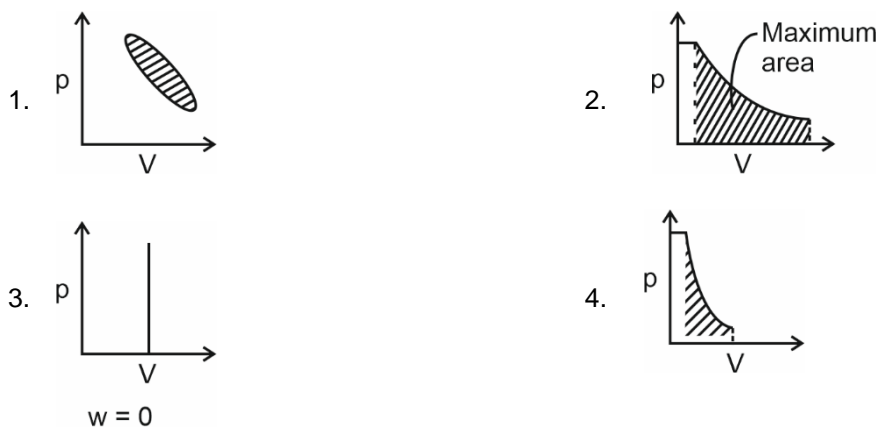

55. Match **List-I** with **List-II**

List-I	List-II
(a) Li	(i) absorbent for carbon dioxide
(b) Na	(ii) electrochemical cells
(c) KOH	(iii) coolant in fast breeder reactors
(d) Cs	(iv) photoelectric cell

Choose the correct answer from the options given below :

- (1) (a) - (iv), (b) - (i), (c) - (iii), (d) - (ii)
- (2) (a) - (iii), (b) - (iv), (c) - (ii), (d) - (i)
- (3) (a) - (i), (b) - (iii), (c) - (iv), (d) - (ii)
- (4) (a) - (ii), (b) - (iii), (c) - (i), (d) - (iv)

Answer (4)

- Sol.**
- Cs is used in photoelectric cell due to its low ionisation enthalpy
 - KOH used to adsorb CO₂ and changes into K₂CO₃
 - Liquid sodium metal is used as a coolant in fast breeder nuclear reactor
 - Lithium is used in electrochemical cells

56. The **incorrect** statement regarding enzymes is

- (1) Enzymes are biocatalysts.
- (2) Like chemical catalysts enzymes reduce the activation energy of bio processes.
- (3) Enzymes are polysaccharides.
- (4) Enzymes are very specific for a particular reaction and substrate.

Answer (3)

Sol. Enzymes are complex nitrogenous organic compounds which are produced by living plants and animals. They are protein molecules of high molecular mass. They are not polysaccharides.

57. Given below are half cell reactions:

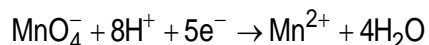

$$E_{\text{Mn}^{2+}/\text{MnO}_4^-}^\circ = -1.510 \text{ V}$$

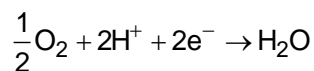

$$E_{\text{O}_2/\text{H}_2\text{O}}^\circ = +1.223 \text{ V}$$

Will the permanganate ion, MnO_4^- liberate O₂ from water in the presence of an acid?

- (1) Yes, because $E_{\text{cell}}^\circ = + 0.287 \text{ V}$
- (2) No, because $E_{\text{cell}}^\circ = - 0.287 \text{ V}$
- (3) Yes, because $E_{\text{cell}}^\circ = + 2.733 \text{ V}$
- (4) No, because $E_{\text{cell}}^\circ = - 2.733 \text{ V}$

Answer (1)

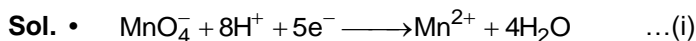

$$E_{\text{MnO}_4^-/\text{Mn}^{2+}}^{\circ} = -E_{\text{Mn}^{2+}/\text{MnO}_4^-}^{\circ} = 1.51 \text{ V}$$

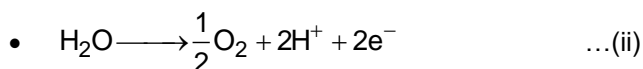

$$E_{\text{O}_2/\text{H}_2\text{O}}^{\circ} = 1.223 \text{ V}$$

Using $2 \times (\text{i}) + 5 \times (\text{ii})$, net cell reactions is

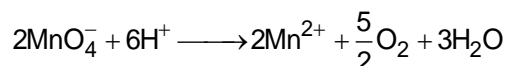

$$E_{\text{cell}}^{\circ} = E_{\text{C}}^{\circ} - E_{\text{A}}^{\circ} = E_{\text{MnO}_4^-/\text{Mn}^{2+}}^{\circ} - E_{\text{O}_2/\text{H}_2\text{O}}^{\circ} = 1.51 - 1.223 = 0.287 \text{ V}$$

Since $E_{\text{cell}}^{\circ} > 0$, therefore net cell reaction is spontaneous and so MnO_4^- liberate O_2 from H_2O in presence of an acid.

58. Which one is not correct mathematical equation for Dalton's Law of partial pressure? Here p = total pressure of gaseous mixture

(1) $p = p_1 + p_2 + p_3$

(2) $p = n_1 \frac{RT}{V} + n_2 \frac{RT}{V} + n_3 \frac{RT}{V}$

(3) $p_i = \chi_i p$,

where p_i = partial pressure of i^{th} gas

χ_i = mole fraction of i^{th} gas in gaseous mixture

(4) $p_i = \chi_i p_i^{\circ}$,

where χ_i = mole fraction of i^{th} gas in gaseous mixture

p_i° = pressure of i^{th} gas in pure state

Answer (4)

Sol. • Dalton's law of partial pressure states that the total pressure by the mixture of non-reactive gases is equal to the sum of the partial pressures of individual gases.

• $p_{\text{Total}} = p_1 + p_2 + p_3$

• Also, $p_i = \chi_i p$; where p_i and χ_i are the partial pressure and mole fraction of i^{th} gas respectively and p is the total pressure.

• $p_{\text{Total}} = p_1 + p_2 + p_3$

$$= n_1 \frac{RT}{V} + n_2 \frac{RT}{V} + n_3 \frac{RT}{V}$$

$$= (n_1 + n_2 + n_3) \frac{RT}{V}$$

59. The pH of the solution containing 50 mL each of 0.10 M sodium acetate and 0.01 M acetic acid is

[Given pK_a of $CH_3COOH = 4.57$]

- (1) 5.57
- (2) 3.57
- (3) 4.57
- (4) 2.57

Answer (1)

Sol. $CH_3COONa + CH_3COOH$, $CH_3COOH(pK_a) = 4.57$

0.1M	0.01M
50 mL	50 mL

It is a mixture of weak acid and salt of its conjugate base. Hence it is acidic buffer.

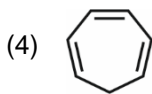
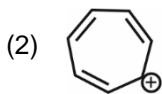
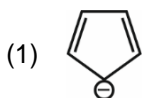

$$\begin{aligned}
 \text{pH} &= \text{p}K_a + \log \frac{[\text{Salt}]}{[\text{Acid}]} \\
 &= 4.57 + \log \left(\frac{0.1}{0.01} \right) \\
 &= 4.57 + 1 \\
 &= 5.57
 \end{aligned}$$

60. Which compound amongst the following is **not** an aromatic compound?



Answer (4)

Sol. • Planar, cyclic, conjugated species containing $(4n + 2)\pi$ electrons will be aromatic in nature (n is an integer)

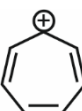
• ,  and  are aromatic species

•  is not an aromatic compound

61. Given below are two statements: one is labelled as **Assertion (A)** and the other is labelled as Reason (R).

Assertion (A): In a particular point defect, an ionic solid is electrically neutral, even if few of its cations are missing from its unit cells.

Reason (R): In an ionic solid, Frenkel defect arises due to dislocation of cation from its lattice site to interstitial site, maintaining overall electrical neutrality.

In the light of the above statements, choose the most appropriate answer from the options given below:

- (1) Both (A) and (R) are correct and (R) is the correct explanation of (A)
- (2) Both (A) and (R) are correct but (R) is not the correct explanation of (A)
- (3) (A) is correct but (R) is not correct
- (4) (A) is not correct but (R) is correct

Answer (2)

- Sol.**
- Assertion statement is classic explanation of Schottky defect in which cation and anion leaves their site, or impurity defect.
 - Reason statement is true but not correct explanation as it is defining Frenkel defect in which ion does not leave crystal.

62. In one molal solution that contains 0.5 mole of a solute, there is

- (1) 500 mL of solvent
- (2) 500 g of solvent
- (3) 100 mL of solvent
- (4) 1000 g of solvent

Answer (2)

Sol. Molality is the moles of solute dissolved per kg of solvent therefore 500 g, 1 molal solution contains 0.5 of solute, as

$$m = \frac{\text{Moles of solute}}{\text{Mass of solvent (in kg)}}$$

$$1 = \frac{0.5}{\text{Mass of solvent (in kg)}}$$

$$\therefore \text{Mass of solvent (in kg)} = 0.5 \\ = 500 \text{ g}$$

63. $\text{RMgX} + \text{CO}_2 \xrightarrow[\text{ether}]{\text{dry}} \text{Y} \xrightarrow{\text{H}_3\text{O}^+} \text{RCOOH}$

What is Y in the above reaction?

- (1) $\text{RCOO-Mg}^+\text{X}$
- (2) $\text{R}_3\text{CO-Mg}^+\text{X}$
- (3) RCOO-X^+
- (4) $(\text{RCOO})_2\text{Mg}$

Answer (1)

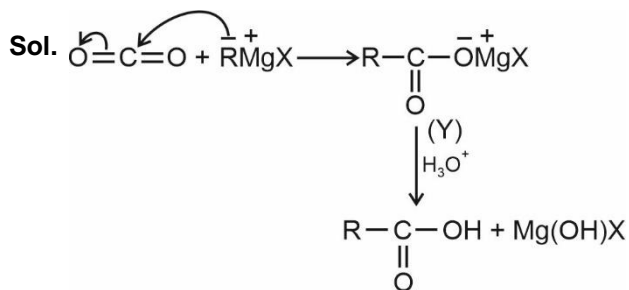

Here Y is $\text{RCOO-Mg}^+\text{X}$

64. Which of the following statement is not correct about diborane?
- (1) There are two 3-centre-2-electron bonds.
 - (2) The four terminal B-H bonds are two centre two electron bonds.
 - (3) The four terminal Hydrogen atoms and the two Boron atoms lie in one plane.
 - (4) Both the Boron atoms are sp^2 hybridised.

Answer (4)

Sol. Each boron atoms in diborane uses sp^3 hybrid orbitals for bonding.

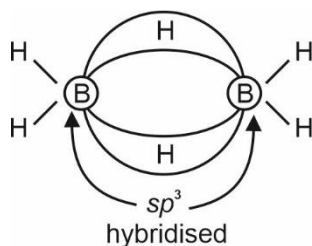

65. Given below are two statements :

Statement I : The boiling points of aldehydes and ketones are higher than hydrocarbons of comparable molecular masses because of weak molecular association in aldehydes and ketones due to dipole - dipole interactions.

Statement II : The boiling points of aldehydes and ketones are lower than the alcohols of similar molecular masses due to the absence of H-bonding.

In the light of the above statements, choose the **most appropriate** answer from the given below

- (1) Both **Statement I** and **Statement II** are correct
- (2) Both **Statement I** and **Statement II** are incorrect
- (3) **Statement I** is correct but **Statement II** is incorrect
- (4) **Statement I** is incorrect but **Statement II** is correct

Answer (1)

- Sol. • The boiling points of aldehydes and ketones are higher than hydrocarbons of comparable molecular masses due to weak molecular association in aldehydes and ketones arising out of the dipole - dipole interaction.
- Alcohols involved intermolecular hydrogen bonding, because of which the boiling point of aldehydes and ketones are lower than the alcohols of similar molecular masses.

66. Amongst the following which one will have maximum 'lone pair - lone pair' electron repulsions?

- (1) ClF_3
- (2) IF_5
- (3) SF_4
- (4) XeF_2

Answer (4)

Sol. $\text{SF}_4 \rightarrow sp^3d + 1$ lone pair

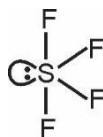

$\text{XeF}_2 \rightarrow sp^3d + 3$ lone pair



$\text{ClF}_3 \rightarrow sp^3d + 2$ lone pair

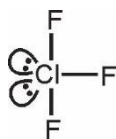

$\text{IF}_5 \rightarrow sp^3d^2 + 1$ lone pair

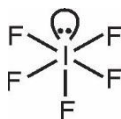

XeF_2 having maximum lone pairs, so, it has maximum 'lone pair-lone pair' electron repulsions.

67. Identify the incorrect statement from the following

- (1) Alkali metals react with water to form their hydroxides.
- (2) The oxidation number of K in KO_2 is +4.
- (3) Ionisation enthalpy of alkali metals decreases from top to bottom in the group.
- (4) Lithium is the strongest reducing agent among the alkali metals.

Answer (2)

Sol. • Alkali metals show only '+1' oxidation state in all of their compounds.

KO_2 is a super-oxide in which O_2^- is anion and K^+ is cation oxidation state of K is +1.

68. What mass of 95% pure CaCO_3 will be required to neutralise 50 mL of 0.5 M HCl solution according to the following reaction?

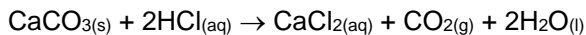

[Calculate upto second place of decimal point]

- (1) 1.25 g
- (2) 1.32 g
- (3) 3.65 g
- (4) 9.50 g

Answer (2)

Sol. Let m gram mass of CaCO_3 is required

$$\text{Pure CaCO}_3 \text{ in } m \text{ gram} = \frac{95}{100} \times m$$

$$\text{Moles of CaCO}_3 = \frac{95}{100} \times \frac{m}{100}$$

Moles of HCl required = $2 \times$ moles of CaCO_3

$$= 2 \times \frac{95}{100} \times \frac{m}{100}$$

$$2 \times \frac{95}{100} \times \frac{m}{100} = \frac{50}{1000} \times 0.5$$

$$m = 1.315 \text{ g} \approx 1.32 \text{ g}$$

69. The given graph is a representation of kinetics of a reaction.

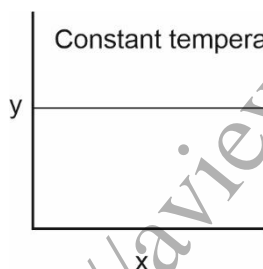

The y and x axes for zero and first order reactions, respectively are

- (1) zero order ($y = \text{concentration}$ and $x = \text{time}$), first order ($y = t_{1/2}$ and $x = \text{concentration}$)
- (2) zero order ($y = \text{concentration}$ and $x = \text{time}$), first order ($y = \text{rate constant}$ and $x = \text{concentration}$)
- (3) zero order ($y = \text{rate}$ and $x = \text{concentration}$), first order ($y = t_{1/2}$ and $x = \text{concentration}$)
- (4) zero order ($y = \text{rate}$ and $x = \text{concentration}$), first order ($y = \text{rate}$ and $x = t_{1/2}$)

Answer (3)

Sol. • For zero order reaction

$$r = k[A]^0$$

$$r = k \text{ (constant)}$$

hence, ' y ' as 'rate' and ' x ' as concentration will give desired graph.

• For first order reaction

$$t_{1/2} = \frac{0.693}{k} \text{ (constant)}$$

hence, ' y ' as ' $t_{1/2}$ ' and ' x ' as concentration will give desired graph.

70. The IUPAC name of the complex-

$[\text{Ag}(\text{H}_2\text{O})_2][\text{Ag}(\text{CN})_2]$ is:

- (1) dicyanosilver(II) diaquaargentate(II)
- (2) diaquasilver(II) dicyanidoargentate(II)
- (3) dicyanosilver(I) diaquaargentate(I)
- (4) diaquasilver(I) dicyanidoargentate(I)

Answer (4)

Sol. $[\text{Ag}(\text{H}_2\text{O})_2][\text{Ag}(\text{CN})_2]$

IUPAC name : diaquasilver(I)dicyanidoargentate(I)

71. Which of the following sequence of reactions is suitable to synthesize chlorobenzene?

- (1) Benzene, Cl_2 , anhydrous FeCl_3
- (2) Phenol, NaNO_2 , HCl , CuCl

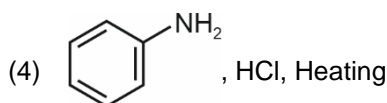
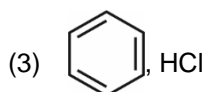

Answer (1)

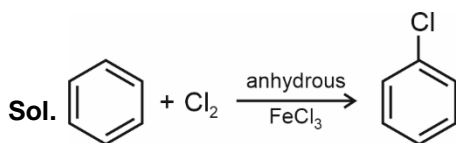

Benzene reacts with chlorine in presence of anhydrous FeCl_3 to give chlorobenzene

72. At 298 K, the standard electrode potentials of $\text{Cu}^{2+} / \text{Cu}$, $\text{Zn}^{2+} / \text{Zn}$, $\text{Fe}^{2+} / \text{Fe}$ and Ag^+ / Ag are 0.34 V, -0.76 V, -0.44 V and 0.80 V, respectively.

On the basis of standard electrode potential, predict which of the following reaction cannot occur?

- (1) $\text{CuSO}_4(\text{aq}) + \text{Zn}(\text{s}) \rightarrow \text{ZnSO}_4(\text{aq}) + \text{Cu}(\text{s})$
- (2) $\text{CuSO}_4(\text{aq}) + \text{Fe}(\text{s}) \rightarrow \text{FeSO}_4(\text{aq}) + \text{Cu}(\text{s})$
- (3) $\text{FeSO}_4(\text{aq}) + \text{Zn}(\text{s}) \rightarrow \text{ZnSO}_4(\text{aq}) + \text{Fe}(\text{s})$
- (4) $2\text{CuSO}_4(\text{aq}) + 2\text{Ag}(\text{s}) \rightarrow 2\text{Cu}(\text{s}) + \text{Ag}_2\text{SO}_4(\text{aq})$

Answer (4)

Sol. For a reaction to be spontaneous, E_{cell}° must be positive.

- For, $\text{FeSO}_4(\text{aq}) + \text{Zn}(\text{s}) \rightarrow \text{ZnSO}_4(\text{aq}) + \text{Fe}(\text{s})$

$$\begin{aligned} E_{\text{cell}}^{\circ} &= E_{\text{cathode}}^{\circ} - E_{\text{anode}}^{\circ} \\ &= -0.44 \text{ V} - (-0.76 \text{ V}) \\ &= 0.32 \text{ V} \end{aligned}$$

- For, $2\text{CuSO}_4(\text{aq}) + 2\text{Ag}(\text{s}) \rightarrow 2\text{Cu}(\text{s}) + \text{Ag}_2\text{SO}_4(\text{aq})$

$$E_{\text{cell}}^{\circ} = 0.34 \text{ V} - 0.80 \text{ V}$$

$$= -0.46 \text{ V}$$

- For, $\text{CuSO}_4(\text{aq}) + \text{Zn}(\text{s}) \rightarrow \text{ZnSO}_4(\text{aq}) + \text{Cu}(\text{s})$

$$E_{\text{cell}}^{\circ} = 0.34 \text{ V} - (-0.76 \text{ V})$$

$$= 1.1 \text{ V}$$

- For, $\text{CuSO}_4(\text{aq}) + \text{Fe}(\text{s}) \rightarrow \text{FeSO}_4(\text{aq}) + \text{Cu}(\text{s})$

$$E_{\text{cell}}^{\circ} = 0.80 \text{ V} - (-0.44 \text{ V})$$

$$= 1.24 \text{ V}$$

73. Given below are two statements

Statement I : The boiling points of the following hydrides of group 16 elements increases in the order –
 $\text{H}_2\text{O} < \text{H}_2\text{S} < \text{H}_2\text{Se} < \text{H}_2\text{Te}$

Statement II : The boiling points of these hydrides increase with increase in molar mass.

In the light of the above statements, choose the most appropriate answer from the options given below :

- Both **Statement I** and **Statement II** are correct
- Both **Statement I** and **Statement II** are incorrect
- Statement I** is correct but **Statement II** is incorrect
- Statement I** is incorrect but **Statement II** is correct

Answer (2)

Sol. Compound	Boiling point (K)
H_2O	373
H_2S	213
H_2Se	232
H_2Te	269

- The boiling points of these hybrids not exactly increases with increase in molar mass.
- H_2O has maximum boiling point due to intermolecular hydrogen bonding.

74. The IUPAC name of an element with atomic number 119 is

- ununennium
- unnilennium
- unununium
- ununoctium

Answer (1)

Sol. IUPAC name of element : 119 : ununennium

75. Given below are two statements

Statement I: Primary aliphatic amines react with HNO_2 to give unstable diazonium salts.

Statement II: Primary aromatic amines react with HNO_2 to form diazonium salts which are stable even above 300 K. In the light of the above statements, choose the most **appropriate** answer from the options given below

- (1) Both Statement I and Statement II are correct.
- (2) Both Statement I and Statement II are incorrect.
- (3) Statement I is correct but Statement II is incorrect.
- (4) Statement I is incorrect but Statement II is correct.

Answer (3)

Sol. • Primary aliphatic amines react with HNO_2 and give unstable diazonium salt which turns into alcohol

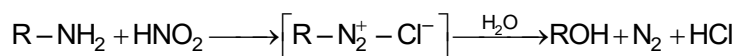

- Primary aromatic amines reacts with HNO_2 and give stable diazonium salt which are stable at 273 to 278 K.

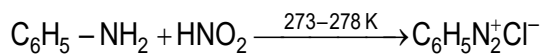

76. Match **List-I** with **List-II**.

List-I	List-II
(Drug class)	(Drug molecule)
(a) Antacids	(i) Salvarsan
(b) Antihistamines	(ii) Morphine
(c) Analgesics	(iii) Cimetidine
(d) Antimicrobials	(iv) Seldane

Choose the correct answer from the options given below :

- (1) (a) - (iii), (b) - (ii), (c) - (iv), (d) - (i)
- (2) (a) - (iii), (b) - (iv), (c) - (ii), (d) - (i)
- (3) (a) - (i), (b) - (iv), (c) - (ii), (d) - (iii)
- (4) (a) - (iv), (b) - (iii), (c) - (i), (d) - (ii)

Answer (2)

- Sol.** • Cimetidine is an antacid
- Seldane is an antihistamine
 - Morphine is an analgesic
 - Salvarsan is an antimicrobial drug

77. Choose the correct statement:

- (1) Diamond and graphite have two dimensional network.
- (2) Diamond is covalent and graphite is ionic.
- (3) Diamond is sp^3 hybridised and graphite is sp^2 hybridized.
- (4) Both diamond and graphite are used as dry lubricants.

Answer (3)

Sol. Diamond : • sp^3 hybridised carbon atom

- Covalent solid
- 3-D structure
- Cannot be used as dry lubricant

Graphite : • sp^2 hybridised carbon atom

- Covalent solid
- 3-D structure
- Used as dry lubricant

78. Given below are two statements: one is labelled as **Assertion (A)** and the other is labelled as **Reason (R)**.

Assertion (A): ICl is more reactive than I_2 .

Reason (R): I-Cl bond is weaker than I-I bond.

In the light of the above statements, choose the most **appropriate** answer from the options given below:

- (1) Both (A) and (R) are correct and (R) is the correct explanation of (A).
- (2) Both (A) and (R) are correct but (R) is not the correct explanation of (A).
- (3) (A) is correct but (R) is not correct.
- (4) (A) is not correct but (R) is correct.

Answer (1)

Sol. In general, interhalogen compounds are more reactive than halogens (except fluorine). This is because X – X' bond in interhalogens is weaker than X – X bond in halogens excepts F – F bond. Therefore I – Cl is more reactive than I_2 because of weaker I – Cl bond then I – I bond.

79. The **incorrect** statement regarding chirality is

- (1) S_N1 reaction yields 1 : 1 mixture of both enantiomers
- (2) The product obtained by S_N2 reaction of haloalkane having chirality at the reactive site shows inversion of configuration
- (3) Enantiomers are superimposable mirror images on each other
- (4) A racemic mixture shows zero optical rotation

Answer (3)

Sol. The stereoisomers related to each other as non-superimposable mirror image are called enantiomers.

80. Match **List-I** with **List-II**.

List-I	List-II
(Hydrides)	(Nature)
(a) MgH_2	(i) Electron precise
(b) GeH_4	(ii) Electron deficient
(c) B_2H_6	(iii) Electron rich
(d) HF	(iv) Ionic

Choose the correct answer from the options given below

- (1) (a) – (iv), (b) – (i), (c) – (ii), (d) – (iii)
- (2) (a) – (iii), (b) – (i), (c) – (ii), (d) – (iv)
- (3) (a) – (i), (b) – (ii), (c) – (iv), (d) – (iii)
- (4) (a) – (ii), (b) – (iii), (c) – (iv), (d) – (i)

Answer (1)

Sol. List-I

(Hydrides)

MgH_2

GeH_4

B_2H_6

HF

(a) – (iv), (b) – (i), (c) – (ii), (d) – (iii)

List-II

(Nature)

Ionic

Electron precise

Electron deficient

Electron rich

81. Which statement regarding polymers is **not correct**?

- (1) Elastomers have polymer chains held together by weak intermolecular forces
- (2) Fibers possess high tensile strength
- (3) Thermoplastic polymers are capable of repeatedly softening and hardening on heating and cooling respectively
- (4) Thermosetting polymers are reusable

Answer (4)

- Sol.**
- Thermoplastic polymers are the linear or slightly long chain molecules capable of repeatedly softening and hardening on cooling.
 - Thermosetting polymers are cross-linked or heavily branched molecules, which on heating undergo extensive cross-linking in moulds and again become infusible. These cannot be reused.
 - Elastomers have polymer chains held together by weak intermolecular forces.
 - Fibres possess high tensile strength.

82. Given below are two statements

Statement I: The acidic strength of monosubstituted nitrophenol is higher than phenol because of electron withdrawing nitro group.

Statement II: *o*-nitrophenol, *m*-nitrophenol and *p*-nitrophenol will have same acidic strength as they have one nitro group attached to the phenolic ring.

In the light of the above statements, choose the **most appropriate** answer from the options given below:

- (1) Both **Statement I** and **Statement II** are correct.
- (2) Both **Statement I** and **Statement II** are incorrect.
- (3) **Statement I** is correct but **Statement II** is incorrect.
- (4) **Statement I** is incorrect but **Statement II** is correct.

Answer (3)

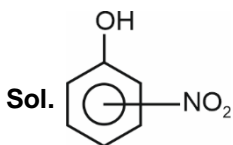

- Nitro group has electron withdrawing tendency. It can withdraw electrons both by $-I$ effect and $-R$ effect. Thus the acidic strength of monosubstituted nitrophenol is higher than phenol.
- Nitro group present at *o*- and *p*-positions will have strong $-R$ effect while nitro group present at *m*-position will influence only $-I$ effect hence acidity of *o/p* isomer will be more than *m* isomer.

83. Given below are two statements

Statement I: In the coagulation of a negative sol, the flocculating power of the three given ions is in the order $Al^{3+} > Ba^{2+} > Na^+$

Statement II: In the coagulation of a positive sol, the flocculating power of the three given salts is in the order $NaCl > Na_2SO_4 > Na_3PO_4$

In the light of the above statements, choose the most **appropriate** answer from the options given below

- (1) Both Statement I and Statement II are correct.
- (2) Both Statement I and Statement II are incorrect.
- (3) Statement I is correct but Statement II is incorrect.
- (4) Statement I is incorrect but Statement II is correct.

Answer (3)

Sol. According to hardy Schulze rule

- Flocculating power of cation increases with increases in charge on cation of electrolyte in case of negatively charge colloid, hence order is
 $Al^{3+} > Ba^{2+} > Na^+$
- Flocculating power of anion increases with increases in charge on anion of electrolyte in case of positively charge colloids
 Hence order is
 $NaCl < Na_2SO_4 < Na_3PO_4$

84. Match List-I with List-II.

List-I	List-II
(Products formed)	(Reaction of carbonyl compound with)
(a) Cyanohydrin	(i) NH_2OH
(b) Acetal	(ii) RNH_2
(c) Schiff's base	(iii) alcohol
(d) Oxime	(iv) HCN

Choose the correct answer from the options given below

- (1) (a) – (iii), (b) – (iv), (c) – (ii), (d) – (i)
- (2) (a) – (ii), (b) – (iii), (c) – (iv), (d) – (i)
- (3) (a) – (i), (b) – (iii), (c) – (ii), (d) – (iv)
- (4) (a) – (iv), (b) – (iii), (c) – (ii), (d) – (i)

Answer (4)

Sol. List-I

(Products formed)

Cyanohydrin

Acetal

Schiff's base

Oxime

(a) – (iv), (b) – (iii), (c) – (ii), (d) – (i)

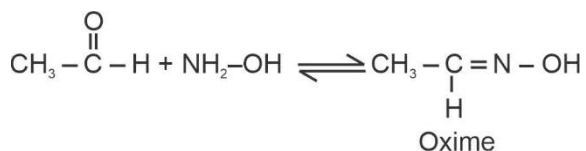
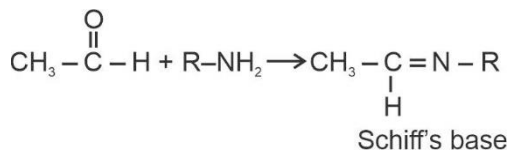
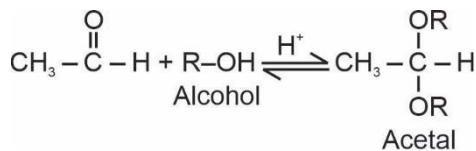
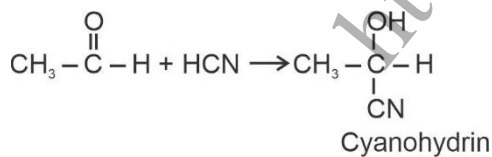

List -II

(Reaction of carbonyl compound with)

HCN

Alcohol

RNH_2

NH_2OH

85. The Kjeldahl's method for the estimation of nitrogen can be used to estimate the amount of nitrogen in which one of the following compounds?

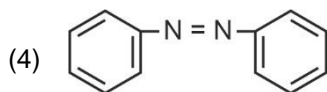
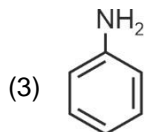
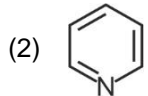
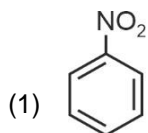

Answer (3)

Sol. Kjeldahl method is not applicable to compounds containing nitrogen in nitro group, azo groups and nitrogen present in the ring (e.g., pyridine) as nitrogen of these compounds does not change to ammonium sulphate under these conditions.

SECTION-B

86. In the neutral or faintly alkaline medium, KMnO_4 oxidises iodide into iodate. The change in oxidation state of manganese in this reaction is from

- (1) +7 to +4
 (2) +6 to +4
 (3) +7 to +3
 (4) +6 to +5

Answer (1)

Sol. In neutral or faintly alkaline solution.

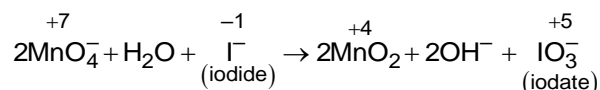

Manganese (Mn) oxidation state change from +7 to +4.

87. Find the emf of the cell in which the following reaction takes place at 298 K

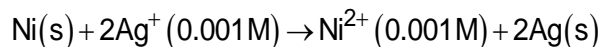

(Given that $E_{\text{cell}}^\circ = 10.5 \text{ V}$, $\frac{2.303 RT}{F} = 0.059$ at 298 K)

- (1) 1.0385 V
 (2) 1.385 V
 (3) 0.9615 V
 (4) 1.05 V

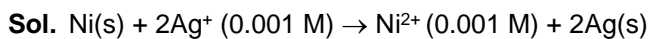
Answer (NA)

$$E_{\text{cell}}^{\circ} = 10.5 \text{ V}$$

$$E_{\text{cell}} = E_{\text{cell}}^{\circ} - \frac{0.059}{n} \log \frac{[\text{Ni}^{2+}]}{[\text{Ag}^+]^2}$$

$$= 10.5 - \frac{0.059}{2} \log \frac{(10^{-3})}{(10^{-3})^2}$$

$$\Rightarrow 10.5 - \frac{0.059}{2} \log(10)^3$$

$$\Rightarrow 10.5 - 0.0295 \times 3$$

$$= 10.5 - 0.0885$$

$$= 10.4115 \text{ V}$$

88. Compound X on reaction with O_3 followed by $\text{Zn}/\text{H}_2\text{O}$ gives formaldehyde and 2-methyl propanal as products. The compound X is

- (1) 3-Methylbut-1-ene
- (2) 2-Methylbut-1-ene
- (3) 2-Methylbut-2-ene
- (4) Pent-2-ene

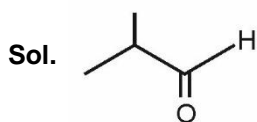
Answer (1)

2-Methylpropanal

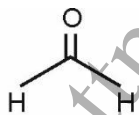

Formaldehyde

The given reaction is the reductive ozonolysis of an alkene. The alkene will be

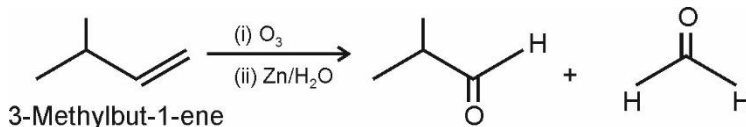

89. $3\text{O}_2(\text{g}) \rightleftharpoons 2\text{O}_3(\text{g})$

for the above reaction at 298 K, K_c is found to be 3.0×10^{-59} . If the concentration of O_2 at equilibrium is 0.040 M then concentration of O_3 in M is

- (1) 4.38×10^{-32}
- (2) 1.9×10^{-63}
- (3) 2.4×10^{31}
- (4) 1.2×10^{21}

Answer (1)

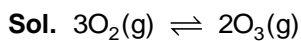

$$K_C = \frac{[\text{O}_3]^2}{[\text{O}_2]^3}$$

$$[\text{O}_3]^2 = K_C[\text{O}_2]^3 = 3 \times 10^{-59} \times (0.04)^3$$

$$[\text{O}_3]^2 = 1.9 \times 10^{-63} = 19 \times 10^{-64}$$

$$[\text{O}_3] = 4.38 \times 10^{-32}$$

Concentration of O_3 at equilibrium = $4.38 \times 10^{-32} \text{ M}$

90. Which one of the following is not formed when acetone reacts with 2-pentanone in the presence of dilute NaOH followed by heating?

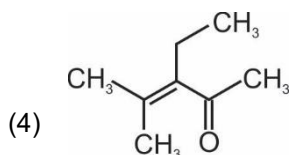
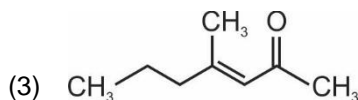
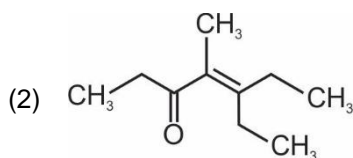
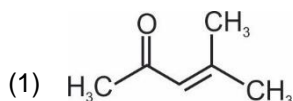

Answer (2)

Sol. Cross Aldol condensation reaction:

Both reactants contain α -Hydrogens, so multiple products are possible which are as follows:

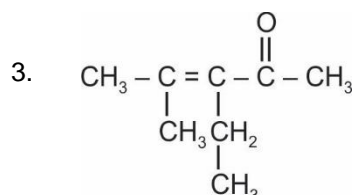
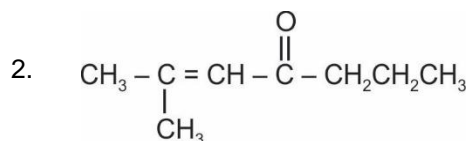
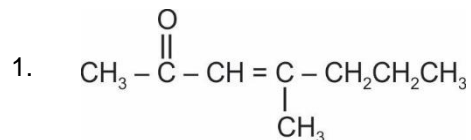
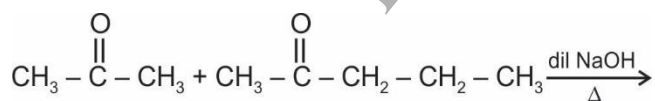

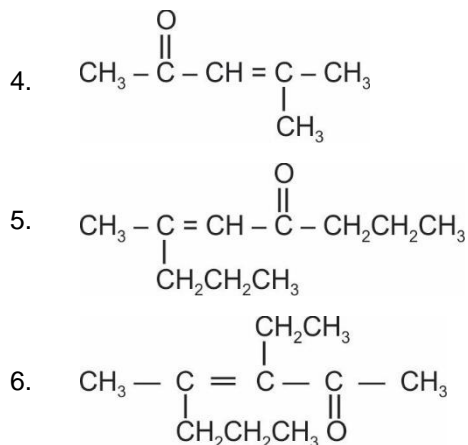

⇒ (2) is not possible.

91. The correct IUPAC name of the following compound is

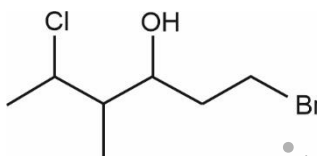

- (1) 1-bromo-5-chloro-4-methylhexan-3-ol
 (2) 6-bromo-2-chloro-4-methylhexan-4-ol
 (3) 1-bromo-4-methyl-5-chlorohexan-3-ol
 (4) 6-bromo-4-methyl-2-chlorohexan-4-ol

Answer (1)

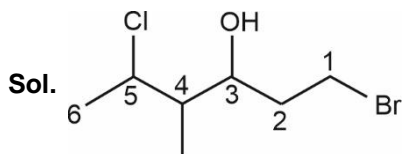

1-bromo-5-chloro-4-methylhexan-3-ol

92. If radius of second Bohr orbit of the He^+ ion is 105.8 pm, what is the radius of third Bohr orbit of Li^{2+} ion?

- (1) 158.7 pm
 (2) 15.87 pm
 (3) 1.587 pm
 (4) 158.7 Å

Answer (1)

Sol. $r_n \propto \frac{n^2}{Z}$

$$\frac{r_3(\text{Li}^{2+})}{r_2(\text{He}^+)} = \frac{(n_3)^2}{Z(\text{Li}^{2+})} \times \frac{Z(\text{He}^+)}{(n_2)^2}$$

$$\frac{r_3(\text{Li}^{2+})}{105.8} = \frac{(3)^2}{3} \times \frac{2}{(2)^2} = 105.8 \times \frac{3}{2}$$

$$r_3(\text{Li}^{2+}) = 158.7 \text{ pm}$$

93. The order of energy absorbed which is responsible for the color of complexes

- (A) $[\text{Ni}(\text{H}_2\text{O})_2(\text{en})_2]^{2+}$
 (B) $[\text{Ni}(\text{H}_2\text{O})_4(\text{en})]^{2+}$ and
 (C) $[\text{Ni}(\text{en})_3]^{2+}$

is

- (1) (A) > (B) > (C)
 (2) (C) > (B) > (A)
 (3) (C) > (A) > (B)
 (4) (B) > (A) > (C)

Answer (3)

Sol. Stronger the field strength of ligand, higher will be the energy absorbed by the complex.

⇒ 'en' has a stronger field strength than 'H₂O' according to spectrochemical series

∴ Correct order of energy absorbed will be:

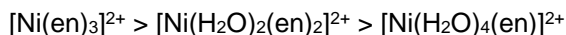

i.e. (C) > (A) > (B)

94. Copper crystallises in fcc unit cell with cell edge length of 3.608×10^{-8} cm. The density of copper is 8.92 g cm^{-3} . Calculate the atomic mass of copper.

- (1) 63.1 u
 (2) 31.55 u
 (3) 60 u
 (4) 65 u

Answer (1)

Sol. $d = \frac{ZM}{N_A(a)^3}$

$Z = 4(\text{FCC}), d = 8.92 \text{ g cm}^{-3}, N_A = 6.023 \times 10^{23}, a = 3.608 \times 10^{-8} \text{ cm}$

$$M = \frac{dN_A(a)^3}{Z}$$

$$= \frac{8.92 \times 6.023 \times 10^{23} \times (3.608 \times 10^{-8})^3}{4}$$

$$= \frac{8.92 \times 6.023 \times 10^{23} \times 46.97 \times 10^{-24}}{4} = \frac{2523.47 \times 10^{-1}}{4}$$

$$= 630.8 \times 10^{-1} = 63.08 \approx 63.1 \text{ u}$$

95. A 10.0 L flask contains 64 g of oxygen at 27°C. (Assume O₂ gas is behaving ideally). The pressure inside the flask in bar is (Given R = 0.0831 L bar K⁻¹ mol⁻¹)

- (1) 2.5
 (2) 498.6
 (3) 49.8
 (4) 4.9

Answer (4)

Sol. We know for ideal gas

$$PV = nRT$$

$$P = n \frac{RT}{V}$$

$$P = \frac{64}{32} \times \frac{0.0831 \times 300}{10}$$

$$P = 4.9 \text{ bar}$$

Pressure of O₂ gas inside the flask = 4.9 bar

96. Match **List-I** with **List-II**.

List-I	List-II
(Ores)	(Composition)
(a) Haematite	(i) Fe ₃ O ₄
(b) Magnetite	(ii) ZnCO ₃
(c) Calamine	(iii) Fe ₂ O ₃
(d) Kaolinite	(iv) [Al ₂ (OH) ₄ Si ₂ O ₅]

Choose the correct answer from the options given below:

- (1) (a)-(i), (b)-(ii), (c)-(iii), (d)-(iv)
- (2) (a)-(iii), (b)-(i), (c)-(ii), (d)-(iv)
- (3) (a)-(iii), (b)-(i), (c)-(iv), (d)-(ii)
- (4) (a)-(i), (b)-(iii), (c)-(ii), (d)-(iv)

Answer (2)

Sol.	(Ores)	(Composition)
(a)	Haematite	→ Fe ₂ O ₃
(b)	Magnetite	→ Fe ₃ O ₄
(c)	Calamine	→ ZnCO ₃
(d)	Kaolinite	→ [Al ₂ (OH) ₄ Si ₂ O ₅]

97. The pollution due to oxides of sulphur gets enhanced due to the presence of:

- (a) particulate matter
- (b) ozone
- (c) hydrocarbons
- (d) hydrogen peroxide

Choose the most appropriate answer from the options given below:

- (1) (a), (d) only
- (2) (a), (b), (d) only
- (3) (b), (c), (d) only
- (4) (a), (c), (d) only

Answer (2)

Sol. Presence of particulate matter in polluted air catalyzes the oxidation of SO_2 to SO_3

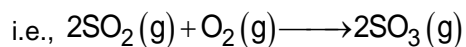

This reaction can also be promoted by O_3 and H_2O_2 , as

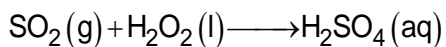
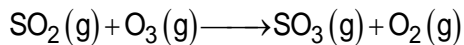

98. The product formed from the following reaction sequence is

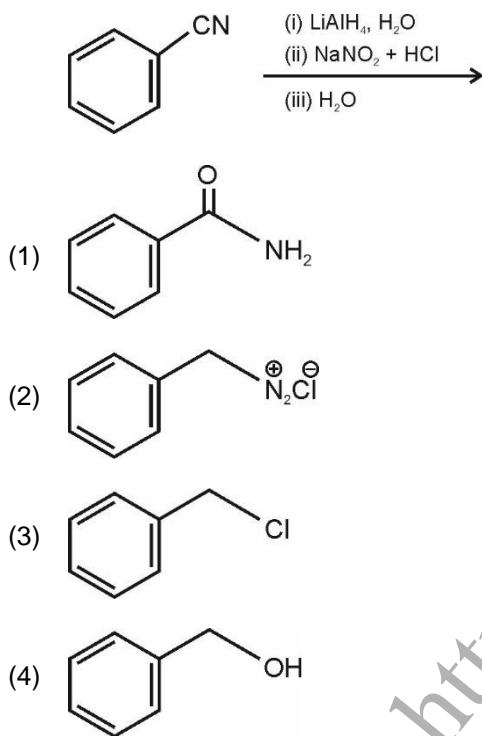
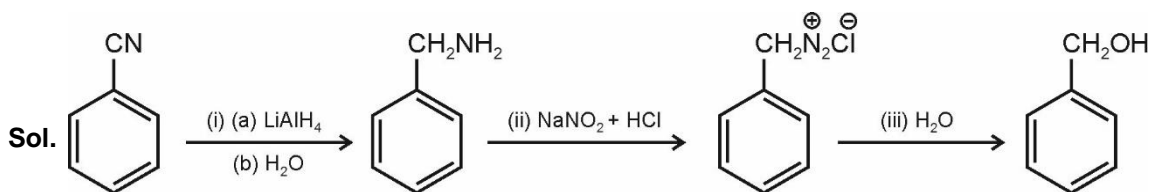
Answer (4)

99. For a first order reaction $\text{A} \rightarrow \text{Products}$, initial concentration of A is 0.1 M, which becomes 0.001 M after 5 minutes. Rate constant for the reaction in min^{-1} is

- (1) 1.3818
- (2) 0.9212
- (3) 0.4606
- (4) 0.2303

Answer (2)

Sol. For first order reaction,

$$K = \frac{2.303}{t} \log \frac{[A_0]}{[A]}; \quad \text{where } A_0 \text{ is the initial concentration of reactant A.}$$

$$A_0 = 0.1 \text{ M}$$

$$A = 0.001 \text{ M}$$

$$t = 5 \text{ minute}$$

$$K = \frac{2.303}{5} \log \frac{0.1}{0.001} = \frac{2.303}{5} \log 10^2$$

$$= \frac{2.303}{5} \times 2$$

$$K = 0.9212 \text{ min}^{-1}$$

100. Given below are two statements:

Statement I: In Lucas test, primary, secondary and tertiary alcohols are distinguished on the basis of their reactivity with conc. HCl + ZnCl₂, known as Lucas Reagent.

Statement II: Primary alcohols are most reactive and immediately produce turbidity at room temperature on reaction with Lucas Reagent.

In the light of the above statements, choose the most appropriate answer from the options given below:

- (1) Both Statement I and Statement II are correct
- (2) Both Statement I and Statement II are incorrect
- (3) Statement I is correct but Statement II is incorrect
- (4) Statement I is incorrect but Statement II is correct

Answer (3)

Sol. Primary, secondary and tertiary alcohols can be differentiated by their reaction with (HCl + anhy ZnCl₂) Lucas reagent

- 3° alcohol $\xrightarrow{\text{ZnCl}_2 + \text{HCl}}$ Immediate turbidity at room temperature
- 2° alcohol $\xrightarrow{\text{ZnCl}_2 + \text{HCl}}$ Turbidity after 5 minutes at room temperature
- 1° alcohol $\xrightarrow{\text{ZnCl}_2 + \text{HCl}}$ Do not gives turbidity at room temperature

BOTANY

SECTION-A

101. Which one of the following plants shows vexillary aestivation and diadelphous stamens?

- (1) *Colchicum autumnale* (2) *Pisum sativum*
(3) *Allium cepa* (4) *Solanum nigrum*

Answer (2)

Sol. • Vexillary aestivation and diadelphous stamens are the characteristic features of family Fabaceae.
• *Pisum sativum* (garden pea) belongs to family Fabaceae.
• *Allium cepa* (onion) and *Colchicum autumnale* (colchicine) belong to family Liliaceae.
• *Solanum nigrum* belongs to Solanaceae.

102. Production of Cucumber has increased manifold in recent years. Application of which of the following phytohormones has resulted in this increased yield as the hormone is known to produce female flowers in the plants :

- (1) ABA (2) Gibberellin
(3) Ethylene (4) Cytokinin

Answer (3)

Sol. Ethylene increases the number of female flowers and fruits in certain plants such as cucumber. Gibberellins are used to increase the size of fruits in some plants.

103. Which one of the following produces nitrogen fixing nodules on the roots of *Alnus*?

- (1) *Rhizobium* (2) *Frankia*
(3) *Rhodospirillum* (4) *Beijerinckia*

Answer (2)

Sol. The microbe, *Frankia*, produces nitrogen fixing nodules on the roots of non-leguminous plants (e.g. *Alnus*)

104. Which of the following is **not** a method of *ex situ* conservation?

- (1) *In vitro* fertilization (2) National Parks
(3) Micropropagation (4) Cryopreservation

Answer (2)

Sol. *In-situ* conservation means on site conservation i.e. when we conserve and protect the whole ecosystem, its biodiversity at all levels is protected.

National parks are type of *in-situ* conservation.

Whereas, micropropagation, cryopreservation and *in-vitro* fertilisation are methods of *ex-situ* conservation.

105. Given below are two statements:

Statement I: Decomposition is a process in which the detritus is degraded into simpler substances by microbes.

Statement II: Decomposition is faster if the detritus is rich in lignin and chitin.

In the light of the above statements, choose the **correct** answer from the options given below:

- (1) Both **Statement I** and **Statement II** are correct
(2) Both **Statement I** and **Statement II** are incorrect
(3) **Statement I** is correct but **Statement II** is incorrect
(4) **Statement I** is incorrect but **Statement II** is correct

Answer (3)

Sol. Decomposition is the process by which decomposers breakdown complex organic matter into inorganic substances.

The rate of decomposition is controlled by chemical composition of detritus and climatic factors. Decomposition is slower if detritus is rich in lignin and chitin and quicker, if detritus is rich in nitrogen and water soluble substances like sugars.

NEET (UG)-2022 (Code-Q2)

106. Hydrocolloid carrageen is obtained from:

- (1) Chlorophyceae and Phaeophyceae
- (2) Phaeophyceae and Rhodophyceae
- (3) Rhodophyceae only
- (4) Phaeophyceae only

Answer (3)

Sol. Hydrocolloids are water holding substances for eg. carrageen obtained from red algae (Rhodophyceae).

107. Identify the **correct** set of statements :

- (a) The leaflets are modified into pointed hard thorns in *Citrus* and *Bougainvillea*
- (b) Axillary buds form slender and spirally coiled tendrils in cucumber and pumpkin
- (c) Stem is flattened and fleshy in *Opuntia* and modified to perform the function of leaves
- (d) *Rhizophora* shows vertically upward growing roots that help to get oxygen for respiration
- (e) Subaerially growing stems in grasses and strawberry help in vegetative propagation

Choose the **correct answer** from the options given below :

- | | |
|--------------------------------|--------------------------------|
| (1) (b) and (c) Only | (2) (a) and (d) Only |
| (3) (b), (c), (d) and (e) Only | (4) (a), (b), (d) and (e) Only |

Answer (3)

Sol. Axillary buds of stems get modified into woody, straight and pointed thorns. Thorns are found in many plants such as *Citrus* and *Bougainvillea*.

108. Which one of the following statements cannot be connected to Predation?

- (1) It helps in maintaining species diversity in a community
- (2) It might lead to extinction of a species
- (3) Both the interacting species are negatively impacted
- (4) It is necessitated by nature to maintain the ecological balance

Answer (3)

Sol. One of the species in predation gains benefit on the expense of the other. Predators help in maintaining species diversity in a community, by reducing the intensity of competition among competing prey species. If a predator is too efficient and overexploits its prey, then the prey might become extinct.

109. Match **List-I** with **List-II**

	List-I		List-II
(a)	Manganese	(i)	Activates the enzyme catalase
(b)	Magnesium	(ii)	Required for pollen germination
(c)	Boron	(iii)	Activates enzymes of respiration
(d)	Iron	(iv)	Functions in splitting of water during photosynthesis

Choose the **correct answer** from the options given below :

- | | |
|--|--|
| (1) (a)-(iii), (b)-(iv), (c)-(i), (d)-(ii) | (2) (a)-(iv), (b)-(iii), (c)-(ii), (d)-(i) |
| (3) (a)-(iv), (b)-(i), (c)-(ii), (d)-(iii) | (4) (a)-(iii), (b)-(i), (c)-(ii), (d)-(iv) |

Answer (2)

Sol. Manganese plays a major role in the splitting of water to liberate oxygen during photosynthesis. Magnesium activates several enzymes involved in photosynthesis and respiration. Boron is involved in pollen germination. Iron activates the catalase and some other enzymes.

110. Given below are two statements : one is labelled as **Assertion (A)** and the other is labelled as **Reason (R)**.

Assertion (A) :

Polymerase chain reaction is used in DNA amplification.

Reason (R) :

The ampicillin resistant gene is used as a selectable marker to check transformation

In the light of the above statements, choose the **correct** answer from the options given below :

- (1) Both **(A)** and **(R)** are correct and **(R)** is the correct explanation of **(A)**
- (2) Both **(A)** and **(R)** are correct but **(R)** is not the correct explanation of **(A)**
- (3) **(A)** is correct but **(R)** is not correct
- (4) **(A)** is not correct but **(R)** is correct

Answer (2)

Sol. Option (2) is the correct answer because both the statements are correct but the given reason is not the correct explanation. Polymerase chain reaction is used in DNA amplification.

Ampicillin resistance gene is a selectable marker that helps to check transformation by selection of transformants.

111. "Girdling Experiment" was performed by Plant Physiologists to identify the plant tissue through which:

- (1) water is transported
- (2) food is transported
- (3) for both water and food transportation
- (4) osmosis is observed

Answer (2)

Sol. The girdling experiment shows that phloem is the tissue responsible for translocation of food; and that transport takes place in one direction *i.e.* towards the root.

112. The gaseous plant growth regulator is used in plants to :

- (1) speed up the malting process
- (2) promote root growth and root hair formation to increase the absorption surface
- (3) help overcome apical dominance
- (4) kill dicotyledonous weeds in the fields

Answer (2)

Sol. Ethylene is a gaseous plant hormone. It induces development of adventitious roots on various types of cutting. It promotes the development of lateral roots and growth of root hairs. Cytokinin helps to overcome the apical dominance.

Auxin is used to kill dicot weeds. Gibberellin speeds up the malting process

113. The device which can remove particulate matter present in the exhaust from a thermal power plant is :

- (1) STP
- (2) Incinerator
- (3) Electrostatic Precipitator
- (4) Catalytic Convertor

Answer (3)

Sol. Electrostatic precipitator can remove over 99% particulate matter present in the exhaust from a thermal power plant. Catalytic converters are fitted into automobiles for reducing emission of poisonous gases. STPs are associated with sewage treatment.

114. The appearance of recombination nodules on homologous chromosomes during meiosis characterizes :

- (1) Synaptonemal complex (2) Bivalent
(3) Sites at which crossing over occurs (4) Terminalization

Answer (3)

Sol. Pachytene stage of meiosis is characterised by the appearance of recombination nodules, the sites at which crossing over occurs between non sister chromatids of homologous chromosomes.

115. Habitat loss and fragmentation, over exploitation, alien species invasion and co-extinction are causes for:

- (1) Population explosion (2) Competition
(3) Biodiversity loss (4) Natality

Answer (3)

Sol. Habitat loss and fragmentation, over exploitation, alien species invasion and co-extinction are causes for biodiversity loss.

116. Given below are two statements :

Statement I :

The primary CO_2 acceptor in C_4 plants is phosphoenolpyruvate and is found in the mesophyll cells.

Statement II :

Mesophyll cells of C_4 plants lack RuBisCo enzyme. In the light of the above statements, choose the **correct** answer from the options given below:

- (1) Both **Statement I** and **Statement II** are correct
(2) Both **Statement I** and **Statement II** are incorrect
(3) **Statement I** is correct but **Statement II** is incorrect
(4) **Statement I** is incorrect but **Statement II** is correct

Answer (1)

Sol. The primary CO_2 acceptor is a 3-carbon molecule, phosphoenol pyruvate (PEP) and is present in the mesophyll cells.

Mesophyll cells of C_4 plants lack RuBisCO enzyme.

117. Identify the **incorrect** statement related to Pollination :

- (1) Pollination by water is quite rare in flowering plants
(2) Pollination by wind is more common amongst abiotic pollination
(3) Flowers produce foul odours to attract flies and beetles to get pollinated
(4) Moths and butterflies are the most dominant pollinating agents among insects

Answer (4)

Sol. Among the animals, insects, particularly bees are the dominant biotic pollinating agents.

118. Which one of the following statement is **not true** regarding gel electrophoresis technique?

- (1) The process of extraction of separated DNA strands from gel is called elution.
(2) The separated DNA fragments are stained by using ethidium bromide.
(3) The presence of chromogenic substrate gives blue coloured DNA bands on the gel.
(4) Bright orange coloured bands of DNA can be observed in the gel when exposed to UV light.

Answer (3)

Sol. Option (3) is the incorrect statement, as bright colored bands of DNA can be observed in the gel when EtBr (Ethidium bromide) treated DNA is exposed to UV light.

119. Read the following statements and choose the set of **correct** statements :
- (a) Euchromatin is loosely packed chromatin
 - (b) Heterochromatin is transcriptionally active
 - (c) Histone octamer is wrapped by negatively charged DNA in nucleosome
 - (d) Histones are rich in lysine and arginine
 - (e) A typical nucleosome contains 400 bp of DNA helix

Choose the correct answer from the options given below :

- (1) (b), (d), (e) Only
- (2) (a), (c), (d) Only
- (3) (b), (e) Only
- (4) (a), (c), (e) Only

Answer (2)

Sol. Heterochromatin is transcriptionally inactive. A typical nucleosome contains 200 bp of DNA helix. Euchromatin is the loosely packed chromatin region.

The negatively charged DNA is wrapped around the positively charged histone octamer to form a structure called nucleosome. Histones are rich in basic amino acid residues lysine and arginine.

120. Given below are two statements :

Statement I :

Mendel studied seven pairs of contrasting traits in pea plants and proposed the Laws of Inheritance.

Statement II :

Seven characters examined by Mendel in his experiment on pea plants were seed shape and colour, flower colour, pod shape and colour, flower position and stem height.

In the light of the above statements, choose the correct answer from the options given below :

- (1) Both **Statement I** and **Statement II** are correct
- (2) Both **Statement I** and **Statement II** are incorrect
- (3) **Statement I** is correct but **Statement II** is incorrect
- (4) **Statement I** is incorrect but **Statement II** is correct

Answer (1)

Sol. Gregor J. Mendel, conducted hybridisation experiments on garden peas and selected 14 true breeding pea plant varieties (seven contrasting traits). Contrasting traits studied were smooth or wrinkled seeds, yellow or green seeds, inflated or constricted pods, green or yellow pods, tall or dwarf plants, violet or white flowers and axial or terminal flower positions.

121. XO type of sex determination can be found in :

- (1) *Drosophila*
- (2) Birds
- (3) Grasshoppers
- (4) Monkeys

Answer (3)

Sol. Grasshopper is an example of XO type of sex determination in which the males have only one X-chromosome besides the autosomes, whereas females have a pair of X-chromosomes.

122. What is the net gain of ATP when each molecule of glucose is converted to two molecules of pyruvic acid?

- (1) Four
- (2) Six
- (3) Two
- (4) Eight

Answer (3)

Sol. During glycolysis, total 4 ATPs are produced from one glucose molecule with a net gain of 2 ATPs.

NEET (UG)-2022 (Code-Q2)

123. Read the following statements about the vascular bundles :

- (a) In roots, xylem and phloem in a vascular bundle are arranged in an alternate manner along the different radii.
- (b) Conjoint closed vascular bundles do not possess cambium
- (c) In open vascular bundles, cambium is present in between xylem and phloem
- (d) The vascular bundles of dicotyledonous stem possess endarch protoxylem
- (e) In monocotyledonous root, usually there are more than six xylem bundles present

Choose the **correct answer** from the options given below :

- (1) (a), (b) and (d) Only
- (2) (b), (c), (d) and (e) Only
- (3) (a), (b), (c) and (d) Only
- (4) (a), (c), (d) and (e) Only

Answer (NA) No option is correct

Sol. All the statements are correct regarding vascular bundles but none of the options with such combination is given.

124. Which one of the following is **not** true regarding the release of energy during ATP synthesis through chemiosmosis? It involves:

- (1) Breakdown of proton gradient
- (2) Breakdown of electron gradient
- (3) Movement of protons across the membrane to the stroma
- (4) Reduction of NADP to NADPH₂ on the stroma side of the membrane

Answer (2)

Sol. Chemiosmosis requires a membrane, a proton pump, a proton gradient and ATP synthase. Energy is used to pump protons across a membrane to create a gradient or a high concentration of protons within the thylakoid lumen.

The NADP reductase enzyme is located on the stroma side of the membrane. Along with the electrons that come from the acceptor of electrons of PS I, protons are necessary for reduction of NADP⁺ to NADPH + H⁺.

The process does not involve breaking of electron gradient.

125. Given below are two statements :

Statement I :

Cleistogamous flowers are invariably autogamous

Statement II :

Cleistogamy is disadvantageous as there is no chance for cross pollination

In the light of the above statements, choose the **correct** answer from the options given below :

- (1) Both **Statement I** and **Statement II** are correct
- (2) Both **Statement I** and **Statement II** are incorrect
- (3) **Statement I** is correct but **Statement II** is incorrect
- (4) **Statement I** is incorrect but **Statement II** is correct

Answer (1)

Sol. Cleistogamous flowers does not open at all. In such flowers autogamy occurs. Lack of cross pollination is a disadvantage of cleistogamy.

126. Exoskeleton of arthropods is composed of :

- | | |
|------------|-----------------|
| (1) Cutin | (2) Cellulose |
| (3) Chitin | (4) Glucosamine |

Answer (3)

Sol. Option (3) is the correct answer as chitin forms the exoskeleton in arthropods and is found in fungal cell wall. N-acetyl glucosamine is the monomeric unit. Cellulose is a polysaccharide. Cutin is a derived lipid.

127. Which of the following is **not** observed during apoplastic pathway ?

- (1) Movement of water occurs through intercellular spaces and wall of the cells
- (2) The movement does not involve crossing of cell membrane
- (3) The movement is aided by cytoplasmic streaming
- (4) Apoplast is continuous and does not provide any barrier to water movement

Answer (3)

Sol. The symplastic system is system of interconnected protoplasts. Neighbouring cells are connected through cytoplasmic strands that extend through plasmodesmata. The water travels through cell cytoplasm and plasmodesmata, hence the movement is relatively slower. Symplastic movement is aided by cytoplasmic streaming.

128. Which one of the following never occurs during mitotic cell division?

- (1) Spindle fibres attach to kinetochores of chromosomes
- (2) Movement of centrioles towards opposite poles
- (3) Pairing of homologous chromosomes
- (4) Coiling and condensation of the chromatids

Answer (3)

Sol. Pairing of homologous chromosomes occurs during prophase I of meiosis.

Coiling and condensation of chromatids, spindle fibres attachment to the kinetochores and movement of centrioles towards opposite poles occur in both mitosis and meiosis.

129. In old trees the greater part of secondary xylem is dark brown and resistant to insect attack due to :

- (a) secretion of secondary metabolites and their deposition in the lumen of vessels.
- (b) deposition of organic compounds like tannins and resins in the central layers of stem.
- (c) deposition of suberin and aromatic substances in the outer layer of stem.
- (d) deposition of tannins, gum, resin and aromatic substances in the peripheral layers of stem.
- (e) presence of parenchyma cells, functionally active xylem elements and essential oils.

Choose the **correct** answer from the options given below:

- | | |
|----------------------|----------------------|
| (1) (a) and (b) Only | (2) (c) and (d) Only |
| (3) (d) and (e) Only | (4) (b) and (d) Only |

Answer (1)

Sol. In old trees, the greater part of secondary xylem is dark brown due to deposition of organic compounds like tannins, resins, oils, gums, aromatic substances and essential oils in the central or innermost layers of the stem. These substances make it hard, durable and resistant to the attacks of micro-organisms and insects.

130. Which one of the following plants does **not** show plasticity?
- (1) Cotton (2) Coriander
(3) Buttercup (4) Maize

Answer (4)

Sol. Plants follow different pathways in response to environment or phases of life to form different kinds of structures. This ability is called plasticity e.g. heterophylly in cotton, coriander and larkspur. In such plants, leaves of juvenile plant are different in a shape from those in mature plants.

Maize does not show plasticity.

131. The flowers are Zygomorphic in:
- (a) Mustard
(b) Gulmohar
(c) *Cassia*
(d) *Datura*
(e) Chilly

Choose the **correct answer** from the options given below:

- (1) (a), (b), (c) Only (2) (b), (c) Only
(3) (d), (e) Only (4) (c), (d), (e) Only

Answer (2)

Sol. When a flower can be divided into two similar halves only in one particular vertical plane, it is zygomorphic for e.g. pea, gulmohar, bean, *Cassia*, Mustard, *Datura* and Chilli show actinomorphic flowers.

132. The process of translation of mRNA to proteins begins as soon as :
- (1) The small subunit of ribosome encounters mRNA
(2) The larger subunit of ribosome encounters mRNA
(3) Both the subunits join together to bind with mRNA
(4) The tRNA is activated and the larger subunit of ribosome encounters mRNA

Answer (1)

Sol. When the small subunit of ribosome encounters an mRNA, the process of translation of the mRNA to protein begins. This process is followed by the binding of bigger/larger subunit.

t-RNA is activated by the addition of amino acid prior to the attachment of ribosome, in the first phase.

133. What amount of energy is released from glucose during lactic acid fermentation?
- (1) Approximately 15% (2) More than 18%
(3) About 10% (4) Less than 7%

Answer (4)

Sol. Less than seven percent of the energy in glucose is released during lactic acid fermentation and not all of it is trapped as high energy bonds of ATP.

134. DNA polymorphism forms the basis of :
- (1) Genetic mapping (2) DNA finger printing
(3) Both genetic mapping and DNA finger printing (4) Translation

Answer (3)

Sol. Polymorphism in DNA sequence is the basis of genetic mapping of human genome as well as of DNA fingerprinting.

135. Which of the following is **incorrectly** matched?

- (1) *Ectocarpus* – Fucoxanthin (2) *Ulothrix* – Mannitol
 (3) *Porphyra* – Floridian Starch (4) *Volvox* – Starch

Answer (2)

Sol. *Ulothrix* is a member of Chlorophyceae (green algae), with reserve food material, starch. Mannitol is stored food material of Phaeophyceae (brown algae).

SECTION-B

136. Match List-I with List-II.

	List-I		List-II
(a)	Metacentric chromosome	(i)	Centromere situated close to the end forming one extremely short and one very long arms
(b)	Acrocentric chromosome	(ii)	Centromere at the terminal end
(c)	Submetacentric	(iii)	Centromere in the middle forming two equal arms of chromosomes
(d)	Telocentric chromosome	(iv)	Centromere slightly away from the middle forming one shorter arm and one longer arm

Choose the **correct answer** from the options given below :

- (1) (a)-(iii), (b)-(i), (c)-(iv), (d)-(ii) (2) (a)-(i), (b)-(iii), (c)-(ii), (d)-(iv)
 (3) (a)-(ii), (b)-(iii), (c)-(iv), (d)-(i) (4) (a)-(i), (b)-(ii), (c)-(iii), (d)-(iv)

Answer (1)

Sol. In metacentric chromosome, centromere is in the middle of the chromosomes. Acrocentric chromosome has centromere close to the end of the chromosome. In submetacentric chromosome, centromere is slightly away from the middle of the chromosome. Telocentric chromosome has terminal centromere.

137. Transposons can be used during which one of the following ?

- (1) Polymerase Chain Reaction (2) Gene Silencing
 (3) Autoradiography (4) Gene sequencing

Answer (2)

Sol. Option (2) is the correct answer as the source of the complementary RNA for RNAi could be mobile genetic elements (transposons) that replicate via an RNA intermediate.

Option (3) is incorrect as autoradiography usually follows hybridisation.

Option (1) is incorrect because polymerase chain reaction is used to make copies of the DNA sample and does not need transposons.

Option (4) is incorrect because transposons are not required during gene sequencing.

138. While explaining interspecific interaction of population, (+) sign is assigned for beneficial interaction, (–) sign is assigned for detrimental interaction and (0) for neutral interaction. Which of the following interactions can be assigned (+) for one species and (–) for another species involved in the interaction ?

- (1) Predation (2) Amensalism
 (3) Commensalism (4) Competition

Answer (1)

Sol. In predation, one species is benefitted where as the other is harmed. It is (+ –) type of population interaction.

139. Which one of the following will accelerate phosphorus cycle?

- (1) Burning of fossil fuels (2) Volcanic activity
(3) Weathering of rocks (4) Rain fall and storms

Answer (3)

Sol. Phosphorus cycle is a sedimentary cycle. Reservoir pool of phosphorus in ecosystem is the earth's crust or lithosphere. Weathering of rocks accelerate phosphorus cycle.

140. Which of the following occurs due to the presence of autosome linked dominant trait ?

- (1) Sickle cell anaemia (2) Myotonic dystrophy
(3) Haemophilia (4) Thalessemia

Answer (2)

Sol. Haemophilia is a X-linked recessive disorder. Thalassemia is an autosomal recessive disorder. Sickle cell anaemia is an autosomal recessive disorder.

Myotonic dystrophy is an autosomal dominant disorder *i.e.* it occurs due to the presence of autosomal linked dominant trait.

141. The anatomy of springwood shows some peculiar features. Identify the **correct** set of statements about springwood.

- (a) It is also called as the earlywood
(b) In spring season cambium produces xylem elements with narrow vessels
(c) It is lighter in colour
(d) The springwood along with autumnwood shows alternate concentric rings forming annual rings
(e) It has lower density

Choose the correct answer from the options given below :

- (1) (a), (b), (d) and (e) Only (2) (a), (c), (d) and (e) Only
(3) (a), (b) and (d) Only (4) (c), (d) and (e) Only

Answer (2)

Sol. Spring wood is also called early wood. It is lighter in colour and has a lower density. The vessels are produced with the wider lumens to transport more water to meet the requirement by increased transpiring surface in spring season.

The spring and autumn wood appear as alternate concentric rings of light and dark colour forming annual rings.

142. Which part of the fruit, labelled in the given figure makes it a false fruit?

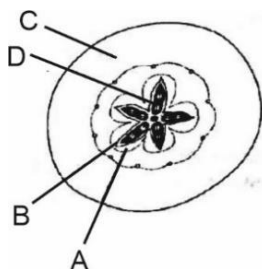

- (1) A → Mesocarp (2) B → Endocarp
(3) C → Thalamus (4) D → Seed

Answer (3)

Sol. The given figure is of a false fruit. False fruit develops from other floral parts and thalamus alongwith the development of ovary wall.

143. What is the role of large bundle sheath cells found around the vascular bundles in C_4 plants?
- (1) To provide the site for photorespiratory pathway
 - (2) To increase the number of chloroplast for the operation of Calvin cycle
 - (3) To enable the plant to tolerate high temperature
 - (4) To protect the vascular tissue from high light intensity

Answer (2)

Sol. The large cells around the vascular bundles of C_4 plants form bundle sheath. These cells have large number of chloroplasts to perform calvin cycle.

144. In the following palindromic base sequences of DNA, which one can be cut easily by particular restriction enzyme?
- (1) 5'GATACT3'; 3'CTATGA5'
 - (2) 5'GAATTC3'; 3'CTTAAG5'
 - (3) 5'CTCAGT3'; 3'GAGTCA5'
 - (4) 5'GTATTC3'; 3'CATAAG5'

Answer (2)

Sol. Option (2) is the correct answer as a palindromic DNA sequence is a DNA sequence of base pairs that reads same on the two strands when orientation of reading is kept the same. Out of the four options, option (2) is the only palindromic sequence.

5'GAATTC3'
3'CTTAAG5'

145. Match the plant with the kind of life cycle it exhibits:

	List-I		List-II
(a)	<i>Spirogyra</i>	(i)	Dominant diploid sporophyte vascular plant, with highly reduced male or female gametophyte
(b)	Fern	(ii)	Dominant haploid free-living gametophyte
(c)	<i>Funaria</i>	(iii)	Dominant diploid sporophyte alternating with reduced gametophyte called prothallus
(d)	<i>Cycas</i>	(iv)	Dominant haploid leafy gametophyte alternating with partially dependent multicellular sporophyte

Choose the **correct answer** from the options given below :

- (1) (a)-(iv), (b)-(i), (c)-(ii), (d)-(iii)
- (2) (a)-(ii), (b)-(iii), (c)-(iv), (d)-(i)
- (3) (a)-(iii), (b)-(iv), (c)-(i), (d)-(ii)
- (4) (a)-(ii), (b)-(iv), (c)-(i), (d)-(iii)

Answer (2)

Sol. *Spirogyra* is an alga. It shows haplontic life-cycle.

Fern is pteridophyte. The dominant phase of life-cycle is diploid sporophyte. Its gametophyte is called prothallus.

Funaria is a bryophyte. Its gametophyte is a leafy stage.

Cycas is a gymnosperm. The main plant body in gymnosperm is sporophyte. They have highly reduced gametophyte stage.

146. Addition of more solutes in a given solution will :

- (1) raise its water potential
- (2) lower its water potential
- (3) make its water potential zero
- (4) not affect the water potential at all

Answer (2)

Sol. If some solute is dissolved in pure water, the solution has lower free water and the concentration of water decreases, reducing its water potential. The magnitude of this lowering due to dissolution of a solute is called solute potential.

NEET (UG)-2022 (Code-Q2)

147. Read the following statements on lipids and find out correct set of statements:
- Lecithin found in the plasma membrane is a glycolipid
 - Saturated fatty acids possess one or more $C=C$ bonds
 - Gingely oil has lower melting point, hence remains as oil in winter
 - Lipids are generally insoluble in water but soluble in some organic solvents
 - When fatty acid is esterified with glycerol, monoglycerides are formed

Choose the correct answer from the option given below:

- (1) (a), (b) and (c) only
- (2) (a), (d) and (e) only
- (3) (c), (d) and (e) only
- (4) (a), (b) and (d) only

Answer (3)

Sol. Option (3) is the correct answer because statements (c), (d) and (e) are correct as oils have lower melting point and hence remain oil in winters. Lipids are generally insoluble in water but soluble in some organic solvents.

Option (1), (2) and (4) are incorrect because statements (a) and (b) are incorrect. Lecithin is a type of phospholipid found in plasma membrane. Saturated fatty acids are without double bond.

148. If a geneticist uses the blind approach for sequencing the whole genome of an organism, followed by assignment of function to different segments, the methodology adopted by him is called as :
- (1) Sequence annotation
 - (2) Gene mapping
 - (3) Expressed sequence tags
 - (4) Bioinformatics

Answer (1)

Sol. Sequencing the whole set of genome that contained all the coding and non-coding sequences and later assigning different regions in the sequence with functions is called sequence annotation.

149. Given below are two statements : one is labelled as **Assertion (A)** and the other is labelled as **Reason (R)**.
Assertion (A) : Mendel's law of Independent assortment does not hold good for the genes that are located closely on the same chromosome.

Reason (R) : Closely located genes assort independently.

In the light of the above statements, choose the **correct** answer from the options given below:

- (1) Both (A) and (R) are correct and (R) is the correct explanation of (A)
- (2) Both (A) and (R) are correct but (R) is not the correct explanation of (A)
- (3) (A) is correct but (R) is not correct
- (4) (A) is not correct but (R) is correct

Answer (3)

Sol. Closely located genes do not show independent assortment. Mendel's law of independent assortment holds good for those genes which are located on different chromosomes.

150. The entire fleet of buses in Delhi were converted to CNG from diesel. In reference to this, which one of the following statements is false?
- (1) CNG burns more efficiently than diesel
 - (2) The same diesel engine is used in CNG buses making the cost of conversion low
 - (3) It is cheaper than diesel
 - (4) It cannot be adulterated like diesel

Answer (2)

Sol. CNG is cheaper than petrol and it burns more efficiently unlike petrol or diesel. It also cannot be adulterated like diesel and petrol. The same diesel engine cannot be used in CNG buses for making the cost conversion low.

SECTION-A

151. In gene therapy of Adenosine Deaminase (ADA) deficiency, the patient requires periodic infusion of genetically engineered lymphocytes because:
- (1) Retroviral vector is introduced into these lymphocytes.
 - (2) Gene isolated from marrow cells producing ADA is introduced into cells at embryonic stages
 - (3) Lymphocytes from patient's blood are grown in culture, outside the body.
 - (4) Genetically engineered lymphocytes are not immortal cells.

Answer (4)

Sol. Option (4) is the correct answer as genetically engineered lymphocytes are not immortal cells and die after some time.

Option (3) is not the correct answer as the lymphocytes from patient's blood are grown in culture, outside the body but it is not the correct reason.

In option (2), if the gene isolated from bone marrow cells producing ADA is introduced into cells at early embryonic stages, it could be a permanent cure.

152. A dehydration reaction links two glucose molecules to product maltose. If the formula for glucose is $C_6H_{12}O_6$ then what is the formula for maltose?
- (1) $C_{12}H_{20}O_{10}$
 - (2) $C_{12}H_{24}O_{12}$
 - (3) $C_{12}H_{22}O_{11}$
 - (4) $C_{12}H_{24}O_{11}$

Answer (3)

Sol. Option (3) is correct because maltose is a disaccharide formed by dehydration process *i.e.*, synthesis by elimination of one water molecule to form a glycosidic bond in between two glucose molecules. So, its molecular formula is.

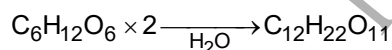

153. Which of the following is a correct match for disease and its symptoms?
- (1) Arthritis – Inflamed joints
 - (2) Tetany – High Ca^{2+} level causing rapid spasms.
 - (3) Myasthenia gravis – Genetic disorder resulting in weakening and paralysis of skeletal muscle
 - (4) Muscular dystrophy – An auto immune disorder causing progressive degeneration of skeletal muscle

Answer (1)

Sol. Option (1) is the correct answer because Arthritis is inflammation of joints.

Option (3) is incorrect because myasthenia gravis is an immune disorder affecting neuro-muscular junction leading to fatigue, weakening and paralysis of skeletal muscle.

Option (4) is incorrect because muscular dystrophy is progressive degeneration of skeletal muscle mostly due to genetic disorder.

Option (2) is incorrect because tetany is rapid spasms in muscle due to low Ca^{++} in body fluid.

154. If '8' *Drosophila* in a laboratory population of '80' died during a week, the death rate in the population is _____ individuals per *Drosophila* per week.
- (1) 0.1
 - (2) 10
 - (3) 1.0
 - (4) zero

Answer (1)

Sol. If 8 *Drosophila* in a laboratory population of 80 died during a week, the death rate in the population is

$$\frac{8}{80} = 0.1 \text{ individuals per } Drosophila \text{ per week.}$$

155. Which of the following statements are true for spermatogenesis but do not hold true for Oogenesis?
- (a) It results in the formation of haploid gametes
 - (b) Differentiation of gamete occurs after the completion of meiosis
 - (c) Meiosis occurs continuously in a mitotically dividing stem cell population
 - (d) It is controlled by the Luteinising hormone (LH) and Follicle Stimulating Hormone (FSH) secreted by the anterior pituitary
 - (e) It is initiated at puberty

Choose the most appropriate answer from the options given below:

- (1) (c) and (e) only
- (2) (b) and (c) only
- (3) (b), (d) and (e) only
- (4) (b), (c) and (e) only

Answer (4)

Sol. Option (4) is the correct answer.

- In both, spermatogenesis and oogenesis haploid gametes are formed. So (a) is true for both.
- The spermatids are transformed into spermatozoa (sperms) by the process called spermiogenesis. Hence, (b) is true for spermatogenesis only.
- Spermatogenesis and oogenesis both are controlled by LH and FSH secreted by the anterior pituitary. Hence (d) is true for both.
- Spermatogenesis is a continuous process that begins at puberty. So (e) is true for spermatogenesis. Oogenesis on the other hand begins during embryonic development of the female.

156. Lippe's loop is a type of contraceptive used as:

- | | |
|-----------------------|--------------------------|
| (1) Cervical barrier | (2) Vault barrier |
| (3) Non-Medicated IUD | (4) Copper releasing IUD |

Answer (3)

Sol. Option (3) is the correct answer because the intrauterine device (IUD) presently available as the non-medicated IUDs, is Lippe's loop.

Option (4) is incorrect as copper releasing IUDs are CuT, Cu7 and multiload 375.

Option (1) and (2) are incorrect as diaphragms, cervical caps and vaults are included in barrier method of contraception.

157. Given below are two statements :

Statement I :

Fatty acids and glycerols cannot be absorbed into the blood.

Statement II :

Specialized lymphatic capillaries called lacteals carry chylomicrons into lymphatic vessels and ultimately into the blood.

In the light of the above statements, choose the **most appropriate** answer from the options given below:

- (1) Both **Statement I** and **Statement II** are correct
- (2) Both **Statement I** and **Statement II** are incorrect
- (3) **Statement I** is correct but **Statement II** is incorrect
- (4) **Statement I** is incorrect but **Statement II** is correct

Answer (1)

Sol. Option (1) is the correct answer because both the statements I and II are correct as fatty acids and glycerol being insoluble in water, cannot be absorbed into the blood. They are first incorporated into small droplets called micelles which move into the intestinal mucosa. They are re-formed into very small protein coated fat globules called chylomicrons which are transported into the lymph vessels (lacteals) in the villi. These lymph vessels ultimately release the absorbed substances into the blood stream.

158. Given below are two statements :

Statement I :

The coagulum is formed of network of threads called thrombins.

Statement II :

Spleen is the graveyard of erythrocytes.

In the light of the above statements, choose the **most appropriate** answer from the options given below :

- (1) Both **Statement I** and **Statement II** are correct
- (2) Both **Statement I** and **Statement II** are incorrect
- (3) **Statement I** is correct but **Statement II** is incorrect
- (4) **Statement I** is incorrect but **Statement II** is correct

Answer (4)

Sol. Option (4) is the correct answer because coagulum or clot is formed mainly of a network of threads called fibrins. Hence, Statement I is incorrect.

RBCs are destroyed in the spleen so spleen is known as the graveyard of erythrocytes. Hence, Statement II is correct.

159. In the taxonomic categories which hierarchical arrangement in ascending order is **correct** in case of animals?

- (1) Kingdom, Phylum, Class, Order, Family, Genus, Species
- (2) Kingdom, Class, Phylum, Family, Order, Genus, Species
- (3) Kingdom, Order, Class, Phylum, Family, Genus, Species
- (4) Kingdom, Order, Phylum, Class, Family, Genus, Species

Answer (1*)

Sol. None of the options are matching with the language of the question

The correct ascending order of taxonomic categories in case of animals is
species → genus → family → order → class → phylum → kingdom

160. Given below are two statements:

Statement I:

Autoimmune disorder is a condition where body defense mechanism recognizes its own cells as foreign bodies.

Statement II:

Rheumatoid arthritis is a condition where body does not attack self cells.

In the light of the above statements, choose the **most appropriate** answer from the options given below:

- (1) are correct **Statement II** and **Statement I** Both
- (2) Both **Statement I** and **Statement II** are incorrect
- (3) is incorrect **Statement II** is correct but **Statement I**
- (4) **Statement I** is incorrect but **Statement II** is correct

Answer (3)

Sol. Option (3) is the correct answer as autoimmune disorder is a condition where body defense mechanism recognises its own cells as foreign bodies. Sometimes, due to genetic and other unknown reasons, the body attacks self- cells.

Rheumatoid arthritis is an example where body attack self-cells (synovial membrane).

So Statement I is correct but Statement II is incorrect.

161. *In-situ* conservation refers to:

- (1) Protect and conserve the whole ecosystem
- (2) Conserve only high-risk species
- (3) Conserve only endangered species
- (4) Conserve only extinct species

Answer (1)

Sol. When we conserve and protect the whole ecosystem, its biodiversity at all levels is protected. This is *in-situ* or on site conservation strategy.

162. Identify the asexual reproductive structure associated with *Penicillium* :

- | | |
|---------------|-------------|
| (1) Zoospores | (2) Conidia |
| (3) Gemmules | (4) Buds |

Answer (2)

Sol. Conidia are the asexual reproductive structures produced in *Penicillium*.

Gemmules are produced in sponge

Buds are produced in *Hydra*

Zoospores are produced in *Chlamydomonas*

163. Which of the following statements with respect to Endoplasmic Reticulum is incorrect?

- (1) RER has ribosomes attached to ER
- (2) SER is devoid of ribosomes
- (3) In prokaryotes only RER are present
- (4) SER are the sites for lipid synthesis

Answer (3)

Sol. In prokaryotes, ER is absent be it RER or SER.

164. Natural selection where more individuals acquire specific character value other than the mean character value, leads to

- (1) Stabilising change
- (2) Directional change
- (3) Disruptive change
- (4) Random change

Answer (2)

Sol. Option (2) is correct because in directional natural selection more individuals acquire value other than the mean character value.

Option (3) is incorrect because in disruptive change, more individuals acquire peripheral character value at both ends of the distribution curve.

Option (4) is incorrect because there is no random change in natural selection.

Option (1) is incorrect because natural selection leads to stabilisation when more individuals acquire mean character value.

165. Nitrogenous waste is excreted in the form of pellet or paste by :

- (1) *Ornithorhynchus*
- (2) *Salamandra*
- (3) *Hippocampus*
- (4) *Pavo*

Answer (4)

Sol. Option (4) is the correct answer because birds (*Pavo*) excrete nitrogenous wastes as uric acid in the form of pellet or paste with a minimum loss of water.

Option (3) and (2) are incorrect because many bony fishes (like *Hippocampus*) and aquatic amphibians (like *Salamandra*) are ammonotelic in nature.

Option (1) is incorrect because mammals (like *Ornithorhynchus*) mainly excrete urea and are called ureotelic animals.

166. Breeding crops with higher levels of vitamins and minerals or higher proteins and healthier fats is called :

- (1) Bio-magnification (2) Bio-remediation
 (3) Bio-fortification (4) Bio-accumulation

Answer (3)

Sol. Breeding crops with higher levels of vitamins and minerals, or higher protein and healthier fats is known as Biofortification.

Biomagnification refers to increase in concentration of the toxicant at successive trophic levels.

Bioremediation is the phenomenon of using biological organism to handle pollution.

167. Which of the following is present between the adjacent bones of the vertebral column?

- (1) Intercalated discs
 (2) Cartilage
 (3) Areolar tissue
 (4) Smooth muscle

Answer (2)

Sol. Option (2) is the correct answer because cartilage forming the intervertebral disc is present between the adjacent bones of the vertebral column and it is a type of cartilaginous joint.

Option (3) is incorrect because areolar tissue present beneath the skin is a type of loose connective tissue.

Option (4) is incorrect because smooth muscles are present in the visceral organs.

Option (1) is incorrect because intercalated discs are characteristic feature of cardiac muscles present in heart.

168. If the length of a DNA molecule is 1.1 metres, what will be the approximate number of base pairs?

- (1) 3.3×10^9 (2) 6.6×10^9
 (3) 3.3×10^6 (4) 6.6×10^6

Answer (1)

Sol. Number of base pairs \times distance between 2 consecutive base pairs = Length of DNA molecule

$$x \cdot 0.34 \times 10^{-9} \text{ m} = 1.1 \text{ m}$$

$$x = \frac{1.1}{0.3 \times 10^{-9}}$$

$$= 3.6 \times 10^9$$

$$\approx 3.3 \times 10^9 \text{ bp}$$

169. Given below are two statements:

Statement I:

Restriction endonucleases recognise specific sequence to cut DNA known as palindromic nucleotide sequence.

Statement II:

Restriction endonucleases cut the DNA strand a little away from the centre of the palindromic site.

In the light of the above statements, choose the **most appropriate** answer from the options given below:

- (1) are correct **Statement II** and **Statement I** Both
- (2) are incorrect **Statement II** and **Statement I** Both
- (3) is incorrect **Statement II** is correct but **Statement I**
- (4) is correct **Statement II** is incorrect but **Statement I**

Answer (1)

Sol. Option (1) is the correct answer because both the statements I and II are correct.

Each restriction endonuclease recognises a specific palindromic nucleotide sequences in the DNA. It will bind to the DNA and cut each of the two strands of double helix at specific points.

Restriction enzymes cut the strand of DNA a little away from the centre of the palindrome site; but between the same two bases on the opposite strands. So both the statements I and II are correct.

170. At which stage of life the oogenesis process is initiated?

- (1) Puberty
- (2) Embryonic development stage
- (3) Birth
- (4) Adult

Answer (2)

Sol. Option (2) is the correct answer as oogenesis is initiated during the embryonic development stage when a couple of million gamete mother cells (oogonia) are formed within each foetal ovary.

No more oogonia are formed and added after birth in a human female.

At puberty only 60,000 to 80,000 primary follicles are left in each ovary, rest degenerate during the phase from birth to puberty.

171. Select the **incorrect** statement with reference to mitosis:

- (1) All the chromosomes lie at the equator at metaphase
- (2) Spindle fibres attach to centromere of chromosomes
- (3) Chromosomes decondense at telophase
- (4) Splitting of centromere occurs at anaphase

Answer (2)

Sol. Spindle fibres attach to the kinetochores of chromosomes.

Kinetochores are the disc shaped structures present on sides of primary constriction or centromere of chromosomes.

172. Given below are two statements : one is labelled as Assertion (A) and the other is labelled as Reason (R).

Assertion (A) : All vertebrates are chordates but all chordates are not vertebrates.

Reason (R) : Notochord is replaced by vertebral column in the adult vertebrates.

In the light of the above statements, choose the **most appropriate** answer from the option given below :

- (1) Both (A) and (R) are correct and (R) is the correct explanation of (A)
- (2) Both (A) and (R) are correct but (R) is not the correct explanation of (A)
- (3) (A) is correct but (R) is not correct
- (4) (A) is not correct but (R) is correct

Answer (1)

Sol. Option (1) is the correct answer because all chordates are divided into three subphyla – Urochordata, Cephalochordata and Vertebrata. In subphylum Vertebrata, notochord is replaced by bony or cartilaginous vertebral column in adults. Therefore, all vertebrates are chordates but all chordates are not vertebrates.

173. In which of the following animals, digestive tract has additional chambers like crop and gizzard?

- (1) *Corvus*, *Columba*, *Chameleon*
- (2) *Bufo*, *Balaenoptera*, *Bangarus*
- (3) *Catla*, *Columba*, *Crocodylus*
- (4) *Pavo*, *Psittacula*, *Corvus*

Answer (4)

Sol. Option (4) is the correct answer because two additional chambers like crop and gizzard in alimentary canal are present in birds.

Pavo (Peacock), *Psittacula* (Parrot), *Corvus* (Crow) and *Columba* (Pigeon) are birds.

Option (1), (2) and (3) are incorrect because *Catla* is a bony fish, *Crocodylus*, *Chameleon* and *Bangarus* are reptiles, *Bufo* is an amphibian and *Balaenoptera* is an aquatic mammal.

174. Which of the following is **not** a connective tissue?

- (1) Blood
- (2) Adipose tissue
- (3) Cartilage
- (4) Neuroglia

Answer (4)

Sol. Option (4) is the correct answer as neuroglia are a part of nervous tissue.

- Neuroglia are the supportive cells of nervous tissue. They make up more than half the volume of neural tissue. Neurons, the unit of neural system are excitable cells.
- Cartilage and blood are specialised type of connective tissues.
- Adipose tissue is a type of loose connective tissue.

175. Under normal physiological conditions in human being every 100 ml of oxygenated blood can deliver _____ ml of O₂ to the tissues.

- (1) 2ml
- (2) 5 ml
- (3) 4ml
- (4) 10 ml

Answer (2)

Sol. Option (2) is the correct answer because every 100 mL of oxygenated blood can deliver around 5 mL of O₂ to the tissues under normal physiological conditions.

Option (3), (4) and (1) are incorrect because every 100 mL of deoxygenated blood delivers approximately 4 mL of CO₂ to the alveoli.

176. In an *E. Coli* strain *i* gene gets mutated and its product can not bind the inducer molecule. If growth medium is provided with lactose, what will be the outcome?

- (1) Only *z* gene will get transcribed
- (2) *z*, *y*, *a* genes will be transcribed
- (3) *z*, *y*, *a* genes will not be translated
- (4) RNA polymerase will bind the promoter region

Answer (3)

Sol. As the product of '*i*' gene binds with the operator region and blocks the transcription and translation of *z*, *y* and *a* genes.

It's product is prevented from binding to the operator by attaching it with the inducer. As the inducer can now no more capable of binding with the repressor, thus, in all the cases, operator always gets attached with the repressor thereby preventing the transcription and transmission of *z*, *y* and *a*.

Even in the presence of lactose, transcription and translation of *z*, *y* and *a* would not occur.

177. Which of the following is not the function of conducting part of respiratory system?

- (1) It clears inhaled air from foreign particles
- (2) Inhaled air is humidified
- (3) Temperature of inhaled air is brought to body temperature
- (4) Provides surface for diffusion of O₂ and CO₂

Answer (4)

Sol. Option (4) is correct because the part starting with the external nostrils upto the terminal bronchioles constitute the conducting part, whereas the alveoli and their ducts form the respiratory or exchange part of the respiratory system.

The conducting part transports the atmospheric air to the alveoli, clears it from foreign particles, humidifies and also bring the air to body temperature. Exchange part is the site of actual diffusion of O₂/CO₂ between blood and atmospheric air.

178. Given below are two statements :

Statement I : Mycoplasma can pass through less than 1 micron filter size.

Statement II : Mycoplasma are bacteria with cell wall.

In the light of the above statements, choose the most appropriate answer from the options given below

- (1) Both Statement I and Statement II is correct
- (2) Both Statement I and Statement II are incorrect
- (3) Statement I is correct but Statement II is incorrect
- (4) Statement I is incorrect but Statement II is correct

Answer (3)

Sol. Mycoplasma are the smallest cells and are only 0.3 μm in length. So it can pass through less than 1 μm filter size.

Mycoplasma lack cell wall.

179. Tegmina in cockroach, arises from

- (1) Prothorax
- (2) Mesothorax
- (3) Metathorax
- (4) Prothorax and Mesothorax

Answer (2)

Sol. Option (2) is the correct answer because tegmina or forewings (the first pair of wings) in cockroach arises from mesothorax.

Options (1), (3) and (4) are incorrect because no wing arises from prothorax and hindwings arise from metathorax.

180. Regarding Meiosis, which of the statements is **incorrect**?

- (1) There are two stages in Meiosis, Meiosis-I and II
- (2) DNA replication occurs in S phase of Meiosis-II
- (3) Pairing of homologous chromosomes and recombination occurs in Meiosis-I
- (4) Four haploid cells are formed at the end of Meiosis-II

Answer (2)

Sol. Meiosis involves two sequential cycles of nuclear and cell division called meiosis-I and meiosis-II but only single cycle of DNA replication.

The stage between two meiotic divisions is called interkinesis and is generally short lived and involves no DNA replication.

181. Which of the following functions is **not** performed by secretions from salivary glands?

- (1) Control bacterial population in mouth
- (2) Digestion of complex carbohydrates
- (3) Lubrication of oral cavity
- (4) Digestion of disaccharides

Answer (4)

Sol. Option (4) is the correct answer because digestion of polysaccharides like starch occurs in mouth and digestion of disaccharides occurs in small intestine.

Option (3) is incorrect because saliva contains mucus which helps in the lubrication of oral cavity.

Option (1) is incorrect because saliva contains an antibacterial agent-lysozyme so that it controls bacterial population in mouth.

Option (2) is incorrect because digestion of complex carbohydrates are performed by secretions from salivary glands.

182. Detritivores breakdown detritus into smaller particles. This process is called:

- (1) Catabolism
- (2) Fragmentation
- (3) Humification
- (4) Decomposition

Answer (2)

Sol. Detritivores)eg. earthworm(break down detritus into smaller particles. This process is called fragmentation.

183. Given below are two statements:

Statement I :

The release of sperms into the seminiferous tubules is called spermiation.

Statement II :

Spermiogenesis is the process of formation of sperms from spermatogonia.

In the light of the above statements, choose the **most appropriate** answer from the options given below :

- (1) Both **Statement I** and **Statement II** are correct
- (2) Both **Statement I** and **Statement II** are incorrect
- (3) **Statement I** is correct but **Statement II** is incorrect
- (4) **Statement I** is incorrect but **Statement II** is correct

Answer (3)

Sol. Option (3) is the correct answer because Statement II is incorrect as the transformation of spermatids into spermatozoa (sperms) are called spermiogenesis. After this, sperm head becomes embedded in the Sertoli cells and are finally released from the seminiferous tubules by the process called spermiation. Hence, Statement I is a correct statement.

Spermatogenesis is the process of formation of sperms from spermatogonia.

184. Given below are two statements : one is labelled as **Assertion (A)** and the other is labelled as **Reason (R)**.

Assertion (A):

Osteoporosis is characterised by decreased bone mass and increased chance of fractures.

Reason (R):

Common cause of osteoporosis is increased levels of estrogen.

In the light of the above statements, choose the **most appropriate** answer from the options given below.

- (1)) Both **(A)** and **(R)** are correct and **(R)** of explanation is the correct **(A)**
- (2) Both **(A)** and **(R)** are correct but **(R)** is not the correct explanation of **(A)**
- (3))**(A)** is correct but **(R)** is not correct (
- (4) **(A)** is not correct but **(R)** is correct

Answer (3)

Sol. Option (3) is the correct answer as osteoporosis is due to decreased levels of oestrogen.

Osteoporosis is an age-related disorder characterised by decreased bone mass hence, the chances of fractures increase.

185. Identify the microorganism which is responsible for the production of an immunosuppressive molecule cyclosporin A :

- (1) *Trichoderma polysporum*
- (2) *Clostridium butylicum*
- (3) *Aspergillus niger*
- (4) *Streptococcus cerevisiae*

Answer (1)

Sol. Bioactive molecule, cyclosporin A, that is used as an immunosuppressive agent in organ transplant patients, is produced by the fungus, *Trichoderma polysporum*.

SECTION-B

186. Match **List-I** with **List-II**

	List-I)Biological Molecules(List-II)Biological functions(
(a)	Glycogen	(i)	Hormone
(b)	Globulin	(ii)	Biocatalyst
(c)	Steroids	(iii)	Antibody
(d)	Thrombin	(iv)	Storage product

Choose the **correct answer** from the options given below:

- (1))a - (iii(,)b) - (ii(,)c) - (iv(,)d) - (i(
- (2))a - (iv(,)b) - (ii(,)c) - (i(,)d) - (iii(
- (3))a - (ii(,)b) - (iv(,)c) - (iii(,)d) - (i(
- (4))a - (iv(,)b) - (iii(,)c) - (i(,)d) - (ii(

Answer (4)

Sol. Option (4) is the correct answer as glycogen is a polysaccharide and is a storage product in animals.

- Globulins form antibodies which are also known as immunoglobulins.
- Steroids form hormones like testosterone.
- Thrombin is a biocatalyst which converts soluble fibrinogen to insoluble fibrin.

187. Match **List-I** with **List-II** with respect to methods of Contraception and their respective actions.

	List-I		List-II
(a)	Diaphragms	(i)	Inhibit ovulation and Implantation
(b)	Contraceptive Pills	(ii)	Increase phagocytosis of sperm within Uterus
(c)	Intra Uterine Devices	(iii)	Absence of Menstrual cycle and ovulation following parturition
(d)	Lactational Amenorrhea	(iv)	They cover the cervix blocking the entry of sperms

Choose the **correct answer** from the options given below:

- (1))a - (iv(,)b) - (i(,)c) - (iii(,)d) - (ii(
- (2))a - (iv(,)b) - (i(,)c) - (ii(,)d) - (iii(
- (3))a - (ii(,)b) - (iv(,)c) - (i(,)d) - (iii(
- (4))a - (iii(,)b) - (ii(,)c) - (i(,)d) - (iv(

190. Which of the following is **not** a desirable feature of a cloning vector?
- (1) Presence of origin of replication (2) Presence of a marker gene
 (3) Presence of single restriction enzyme site (4) Presence of two or more recognition sites

Answer (4)

Sol. Option (4) is the correct answer. Cloning vectors are the carriers of the desired gene in the host cell. The features desirable in a cloning vector are:-

- Presence of origin of replication
- Presence of marker genes
- Presence of very few, preferably single recognition site for the commonly used restriction enzymes

191. Given below are two statements:

Statements I :

In a scrubber the exhaust from the thermal plant is passed through the electric wires to charge the dust particles.

Statement II :

Particulate matter (PM 2.5) cannot be removed by scrubber but can be removed by an electrostatic precipitator.

In the light of the above statements, choose the **most appropriate** answer from the options given below :

- (1) Both **Statement I** and **Statement II** are correct
 (2) Both **Statement I** and **Statement II** are incorrect
 (3) **Statement I** is correct but **Statement II** is incorrect
 (4) **Statement I** is incorrect but **Statement II** is correct

Answer (4)

Sol. Scrubber is used by the industries which produce SO_2 as a by product.

The limestone present in slurry of scrubber remove SO_2 from the exhaust.

Electrostatic precipitator is the most effective device to remove 99% of particulate matter, 'even PM 2.5' present in the exhaust.

192. Select the **incorrect** statement with respect to acquired immunity.

- (1) response is produced when our body encounters a pathogen for the first time Primary.
 (2) Anamnestic response is elicited on subsequent encounters with the same pathogen.
 (3) Anamnestic response is due to memory of first encounter.
 (4) Acquired immunity is non-specific type of defense present at the time of birth.

Answer (4)

Sol. Option (4) is the correct answer as acquired immunity is a specific type of defence which is not present at the time of birth.

Option (1), (2) and (3) are true statements and hence cannot be the answer.

Anamnestic response or secondary immune response is a highly intensified response due to memory of first encounter.

When our body encounters a pathogen for the first time then the body elicits the primary immune response.

When there is a subsequent encounter with the same pathogen, secondary or anamnestic immune response is elicited.

193. Which one of the following statements is **correct**?

- (1) The atrio-ventricular node (AVN) generates an action potential to stimulate atrial contraction
- (2) The tricuspid and the bicuspid valves open due to the pressure exerted by the simultaneous contraction of the atria
- (3) Blood moves freely from atrium to the ventricle during joint diastole.
- (4) Increased ventricular pressure causes closing of the semilunar valves.

Answer (3)

Sol. Option (3) is the correct answer because during joint diastole, blood moves freely from atrium to ventricle as atrioventricular valve remain open during joint diastole.

Option (4) is incorrect because decrease in ventricular pressure, during ventricular diastole closes semilunar valves to produce 'dub' heart sound.

Option (1) is incorrect because SA node generates action potential to stimulate atrial contraction.

Option (2) is incorrect because bicuspid and tricuspid valves open due to pressure exerted by blood present in atria and decrease in pressure in ventricles during ventricular diastole.

194. Ten *E.coli* cells with ^{15}N - dsDNA are incubated in medium containing ^{14}N nucleotide. After 60 minutes, how many *E.coli* cells will have DNA totally free from ^{15}N ?

- (1) 20 cells
- (2) 40 cells
- (3) 60 cells
- (4) 80 cells

Answer (3)

Sol. From 10 parent *E.coli* cells

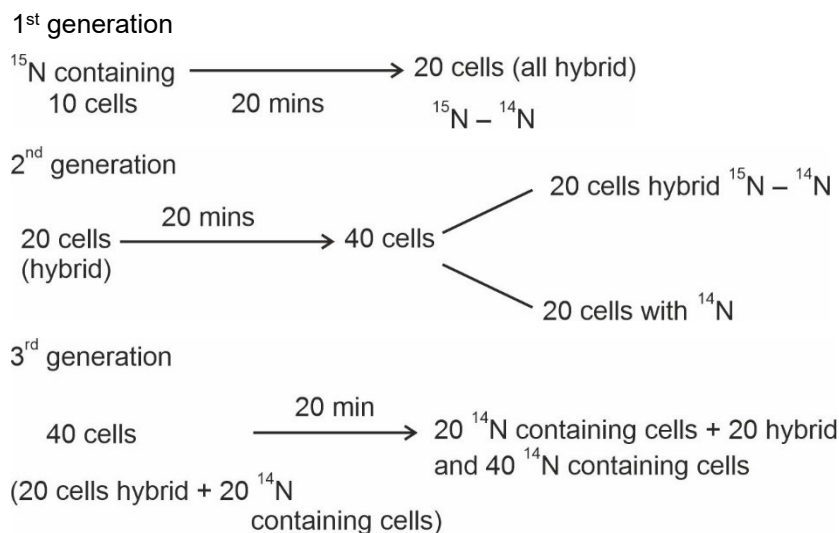

Therefore, after 60 minutes, 60 *E.coli* cells will have DNA totally free from ^{15}N .

195. Which of the following is a **correct** statement?

- (1) Cyanobacteria are a group of autotrophic organisms classified under kingdom Monera.
- (2) Bacteria are exclusively heterotrophic organisms.
- (3) Kingdom Monera Slime moulds are saprophytic organisms classified under.
- (4) Mycoplasma have DNA, ribosome and cell wall.

Answer (1)

Sol. Slime moulds are classified under kingdom Protista.

Mycoplasma lack cell wall.

Bacteria can be autotrophic as well as heterotrophic.

196. Which of the following statements is **not** true?

- (1) Analogous structures are a result of convergent evolution
- (2) Sweet potato and potato is an example of analogy
- (3) Homology indicates common ancestry
- (4) Flippers of penguins and dolphins are a pair of homologous organs

Answer (4)

Sol. Option (4) is the correct answer because flippers of penguins and dolphins are analogous organs as they help in swimming but do not have the same structure.

Option (1), (2) and (3) are true statements and hence cannot be the correct answer.

Homologous organs have the same structure but have different functions according to the needs of the organisms. Hence, homology indicates common ancestry.

Analogous structures have developed for the same function but do not show a similarity in structure. Hence, they are a result of convergent evolution.

Sweet potato is a root modification for food storage whereas potato is an underground stem modification for storage. Hence they are analogous.

197. Statements related to human Insulin are given below.

Which statement(s) is/are **correct** about genetically engineered Insulin?

- (a) Pro-hormone insulin contain extra stretch of C-peptide
- (b) A-peptide and B-peptide chains of insulin were produced separately in *E.coli*, extracted and combined by creating disulphide bond between them.
- (c) Insulin used for treating Diabetes was extracted from Cattles and Pigs.
- (d) Pro-hormone Insulin needs to be processed for converting into a mature and functional hormone.
- (e) Some patients develop allergic reactions to the foreign insulin.

Choose **the most appropriate** answer from the options given below:

- (1) (a), (b) and (d) only
- (2) (b) only
- (3) (c) and (d) only
- (4) (c), (d) and (e) only

Answer (2)

Sol. Option (2) is the correct answer as genetically engineered insulin has A-peptide and B-peptide chains of insulin which are produced separately in *E.coli*, then they are extracted and combined by creating disulphide bond between them.

Statement (a) is incorrect as genetically engineered insulin does not have an extra stretch of C-peptide.

Statement (c) is incorrect as insulin obtained from cattles and pigs is not genetically engineered insulin.

Statement (d) is incorrect because conversion of pro-insulin to insulin is not required during production of insulin by genetic engineering as A-peptide and B-peptide chains are produced separately.

Statement (e) is incorrect as allergic reactions to insulin are mostly seen when the insulin is obtained from animals.

198. Select the **incorrect** statement regarding synapses :

- (1) The membranes of presynaptic and postsynaptic neurons are in close proximity in an electrical synapse.
- (2) Electrical current can flow directly from one neuron into the other across the electrical synapse.
- (3) Chemical synapses use neurotransmitters
- (4) Impulse transmission across a chemical synapse is always faster than that across an electrical synapse.

Answer (4)

Sol. Option (4) is the correct answer as impulse transmission across an electrical synapse is always faster than that across a chemical synapse.

- Chemical synapses use chemicals for transmission which are known as neurotransmitters.
- The membranes of presynaptic and postsynaptic neurons are in close proximity in an electrical synapse.
- In an electrical synapse, the transmission of the impulse occurs in the form of an electrical current from one neuron to the next neuron.

199. Which of the following are **not** the effects of Parathyroid hormone?

- (a) Stimulates the process of bone resorption
- (b) Decreases Ca^{2+} level in blood
- (c) Reabsorption of Ca^{2+} by renal tubules
- (d) Decreases the absorption of Ca^{2+} from digested food
- (e) Increases metabolism of carbohydrates

Choose the **most appropriate** answer from the options given below:

- (1))a (and)c (only
- (2) (b), (d) and (e) only
- (3))a (and)e (only
- (4) (b) and (c) only

Answer (2)

Sol. Option (2) is the correct answer because parathyroid hormone is a hypercalcemic hormone *i.e.*, it increases the blood calcium levels. It also increases the absorption of calcium from digested food. Glucocorticoids regulate the carbohydrate metabolism.

Option (3) is not the answer because parathyroid hormone stimulates the process of bone resorption.

Option (1) and (4) are not the answers because reabsorption of Ca^{2+} by renal tubules is a function of PTH.

200. Match **List-I** with **List-II**

	List-I		List-II
(a)	Bronchioles	(i)	Dense Regular Connective Tissue
(b)	Goblet Cell	(ii)	Loose Connective Tissue
(c)	Tendons	(iii)	Glandular Tissue
(d)	Adipose Tissue	(iv)	Ciliated Epithelium

Choose the **correct answer** from the options given below:

- (1))a - (iv(,)b) - (iii(,)c) - (i(,)d) - (ii(
- (2))a - (i(,)b) - (ii(,)c) - (iii(,)d) - (iv(
- (3))a - (ii(,)b) - (i(,)c) - (iv(,)d) - (iii(
- (4))a - (iii(,)b) - (iv(,)c) - (ii(,)d) - (i(

Answer (1)

Sol. Option (1) is the correct answer because

Ciliated epithelium is mainly present in the inner surface of hollow organs like bronchioles and fallopian tubes. The function is to move particles or mucus in a specific direction over the epithelium.

Some of the columnar or cuboidal cells get specialised for secretion and are called glandular epithelium. Goblet cells are unicellular glands.

Tendons are dense regular connective tissues. They attach skeletal muscles to bones.

Adipose tissue is a type of loose connective tissue located mainly beneath the skin. The cells of this tissue are specialised to store fats.

